

SWS 10-OP NB

Linear bushing

TYPE: Shaft guidance systems, Linear bushing, Standard, Open type for support rail, Type SW..OP, American standard, Corrosion resistance, Stainless steel cage (NB)

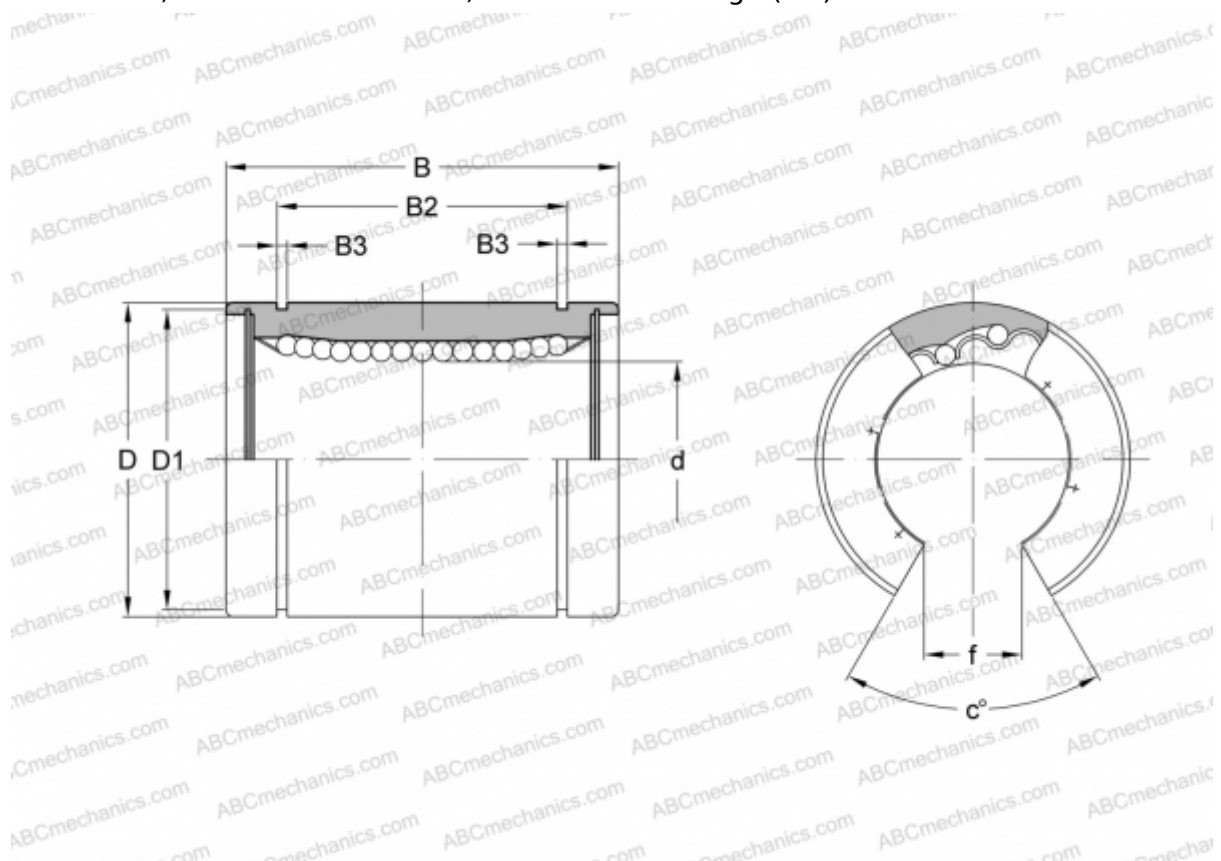

Technical specification

DIMENSIONS, MM

d	15,875
D	28,575
B	38,100
D1	26,899
B2	28,040
B3	1,422
f	9,525
c	80

WEIGHT, KG 0,064

MANUFACTURER [NB](#)