

SWS 24-OP NB

Linear bushing

TYPE: Shaft guidance systems, Linear bushing, Standard, Open type for support rail, Type SW..OP, American standard, Corrosion resistance, Stainless steel cage (NB)

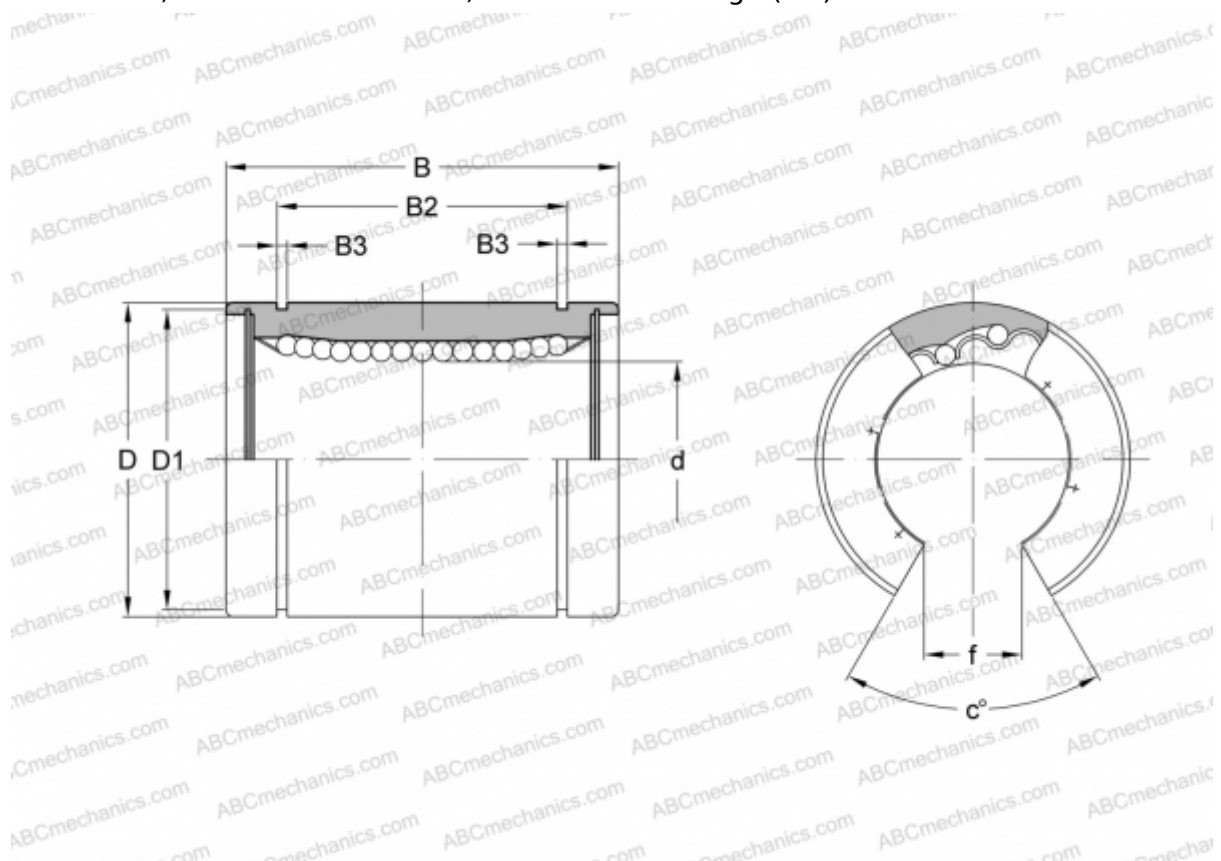

Technical specification

DIMENSIONS, MM

d	38,100
D	60,325
B	76,200
D1	56,870
B2	61,260
B3	2,184
f	19,050
c	50

WEIGHT, KG 0,610

MANUFACTURER [NB](#)