

## SWS 20G-OP NB

Linear bushing

TYPE: Shaft guidance systems, Linear bushing, Standard, Open type for support rail, Type SW..OP, American standard, Corrosion resistance, Plastic cage (NB)

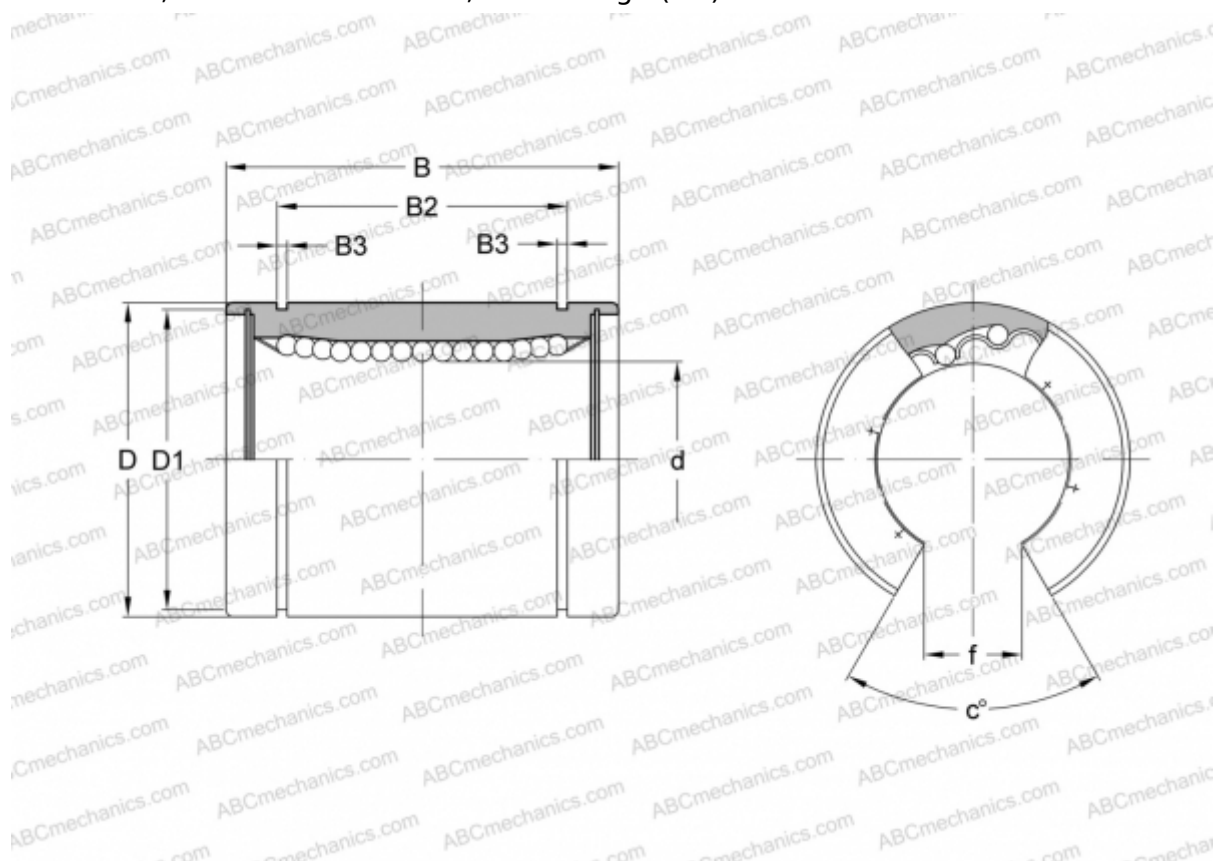

### Technical specification

#### DIMENSIONS, MM

d	31,750
D	50,800
B	66,675
D1	47,904
B2	50,920
B3	1,727
f	15,875
c	50

**WEIGHT, KG** 0,390

**MANUFACTURER** [NB](#)