

## SW 4W NB

Linear bushing

TYPE: Shaft guidance systems, Linear bushing, Standard, Close type, double length, Type SW..W, American standard, Steel cage (NB)

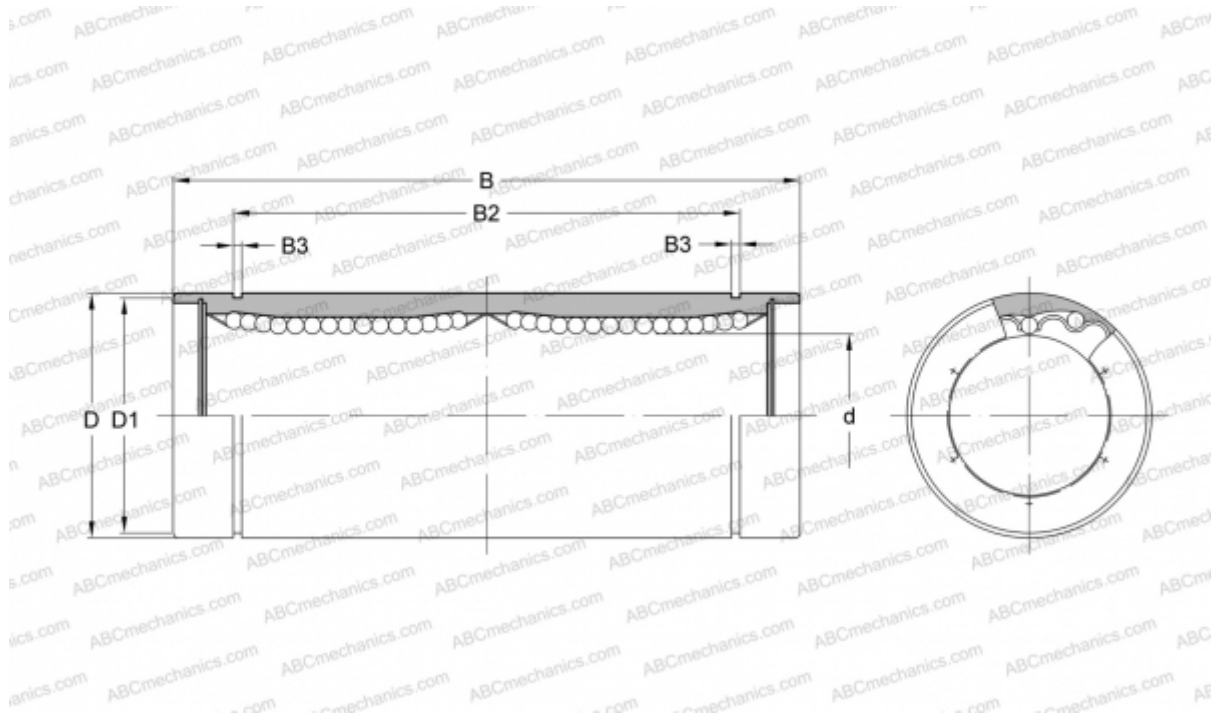

### Technical specification

#### DIMENSIONS, MM

d	6,350
D	12,700
B	34,925
D1	11,906
B2	25,959
B3	0,992

**WEIGHT, KG** 0,018

**MANUFACTURER** [NB](#)