

## SW 8W NB

Linear bushing

TYPE: Shaft guidance systems, Linear bushing, Standard, Close type, double length, Type SW..W, American standard, Steel cage (NB)

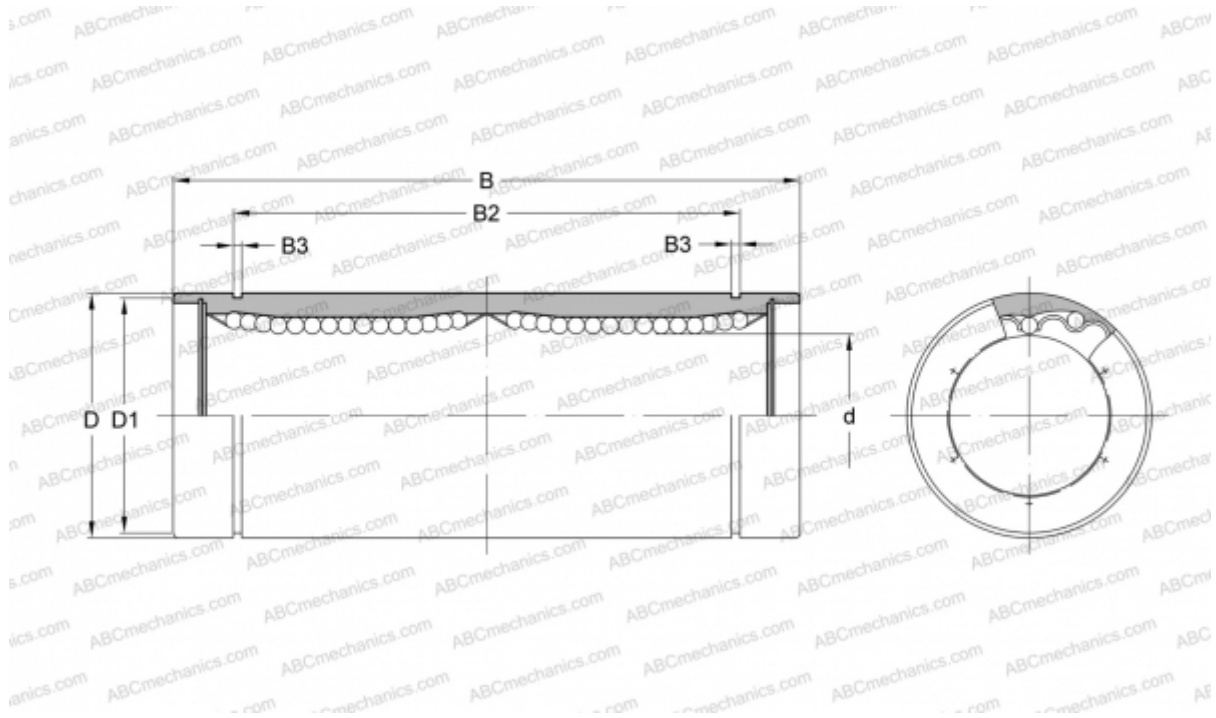

### Technical specification

#### DIMENSIONS, MM

d	12,700
D	22,225
B	60,325
D1	20,853
B2	48,895
B3	1,168

**WEIGHT, KG** 0,080

**MANUFACTURER** [NB](#)