

## SW 10W NB

Linear bushing

TYPE: Shaft guidance systems, Linear bushing, Standard, Close type, double length, Type SW..W, American standard, Steel cage (NB)

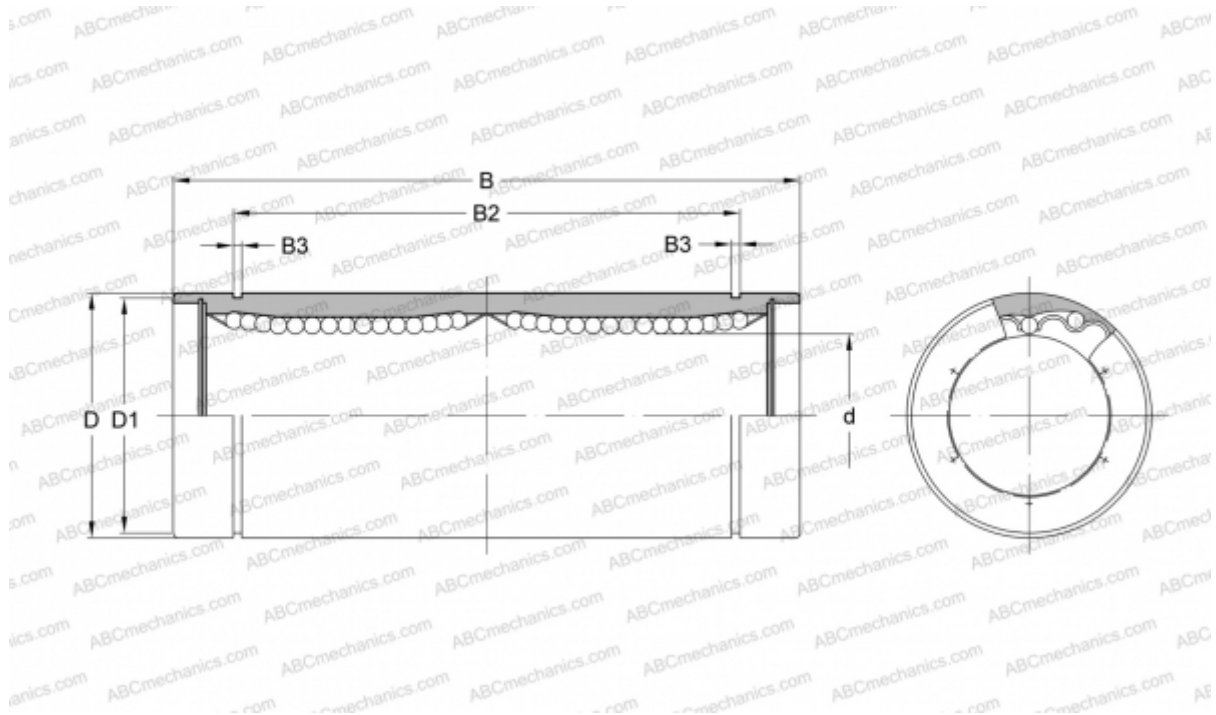

### Technical specification

#### DIMENSIONS, MM

d	15,875
D	28,575
B	71,438
D1	26,899
B2	56,080
B3	1,422

**WEIGHT, KG** 0,160

**MANUFACTURER** [NB](#)