

## SW 16W NB

Linear bushing

TYPE: Shaft guidance systems, Linear bushing, Standard, Close type, double length, Type SW..W, American standard, Steel cage (NB)

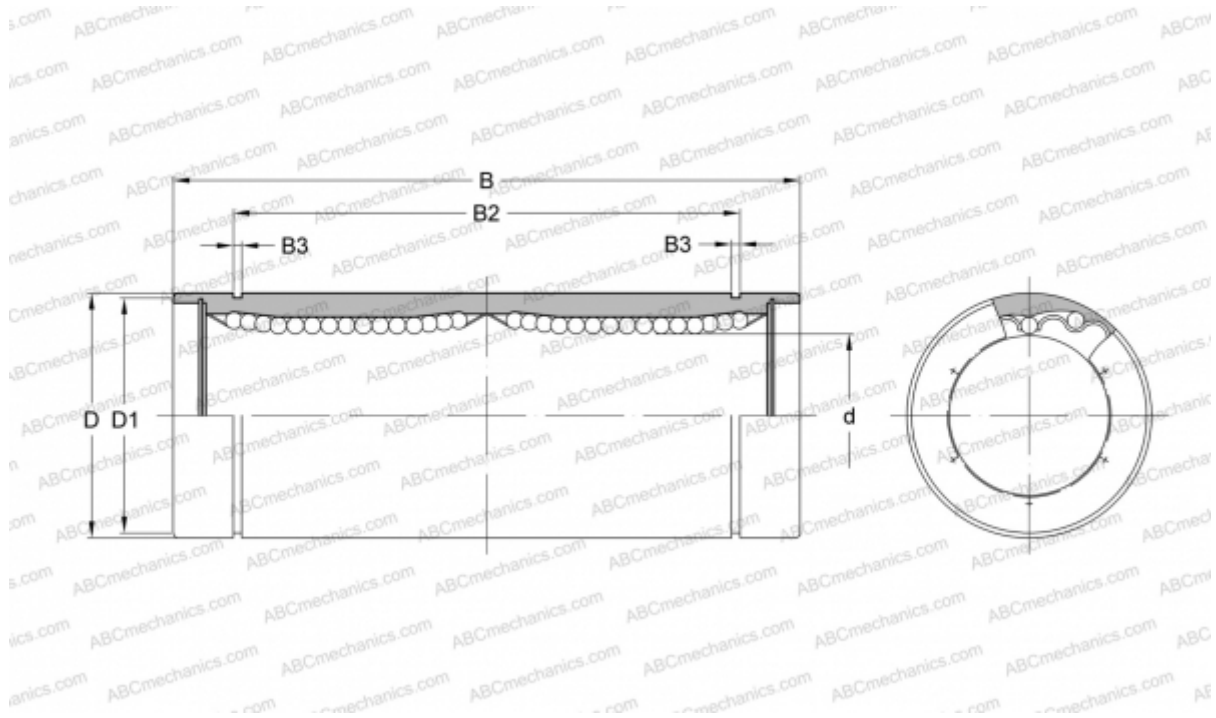

### Technical specification

#### DIMENSIONS, MM

d	25,400
D	39,688
B	108,744
D1	37,306
B2	89,139
B3	1,727

**WEIGHT, KG** 0,410

**MANUFACTURER** [NB](#)