

SW 6GW NB

Linear bushing

TYPE: Shaft guidance systems, Linear bushing, Standard, Close type, double length, Type SW..W, American standard, Plastic cage (NB)

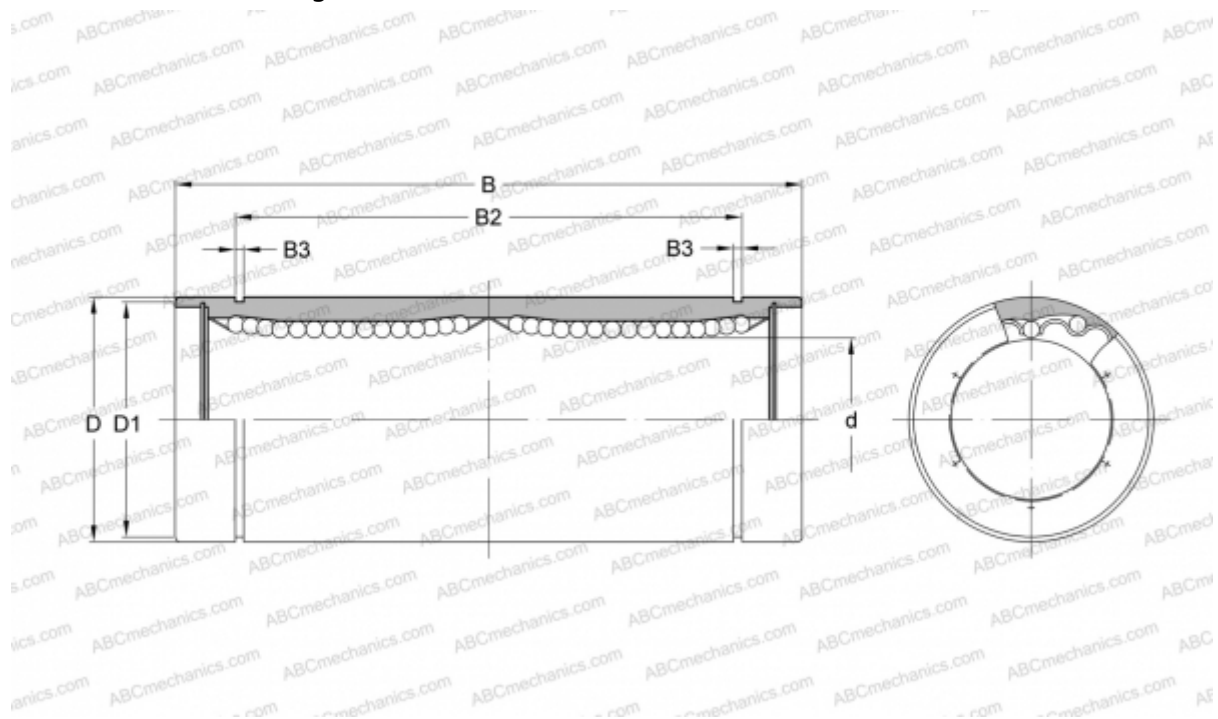

Technical specification

DIMENSIONS, MM

d	9,525
D	15,875
B	40,481
D1	14,935
B2	32,298
B3	0,992

WEIGHT, KG 0,028

MANUFACTURER [NB](#)