

## SW 12GW NB

Linear bushing

TYPE: Shaft guidance systems, Linear bushing, Standard, Close type, double length, Type SW..W, American standard, Plastic cage (NB)

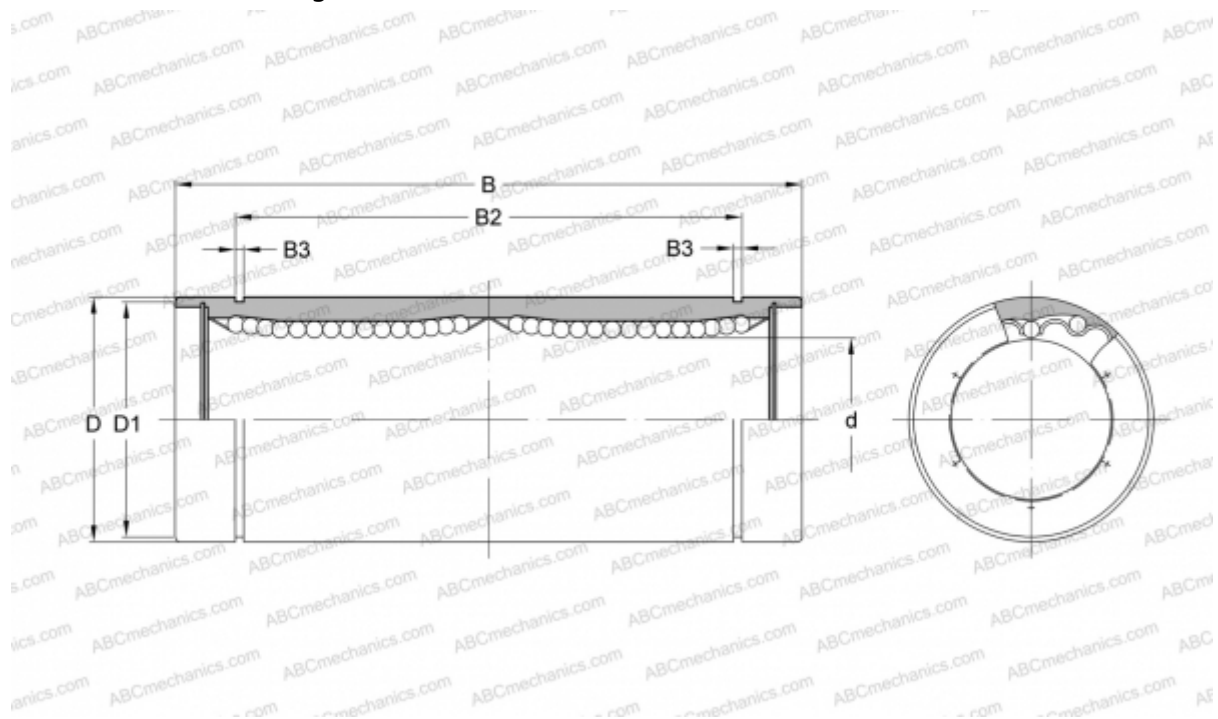

### Technical specification

#### DIMENSIONS, MM

d	19,050
D	31,750
B	78,581
D1	29,870
B2	59,218
B3	1,422

**WEIGHT, KG** 0,195

**MANUFACTURER** [NB](#)