

SWS 4GW NB

Linear bushing

TYPE: Shaft guidance systems, Linear bushing, Standard, Close type, double length, Type SW..W, American standard, Corrosion resistance, Plastic cage (NB)

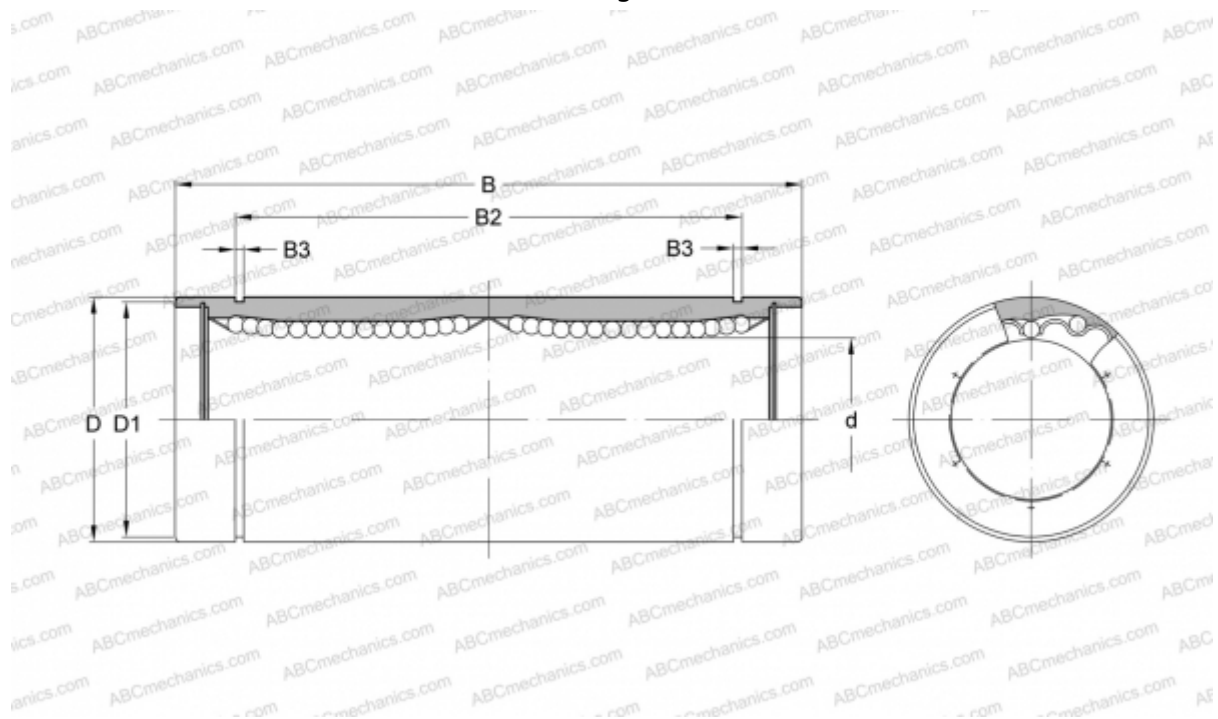

Technical specification

DIMENSIONS, MM

d	6,350
D	12,700
B	34,925
D1	11,906
B2	25,959
B3	0,992

WEIGHT, KG 0,018

MANUFACTURER [NB](#)