

SWS 8GW NB

Linear bushing

TYPE: Shaft guidance systems, Linear bushing, Standard, Close type, double length, Type SW..W, American standard, Corrosion resistance, Plastic cage (NB)

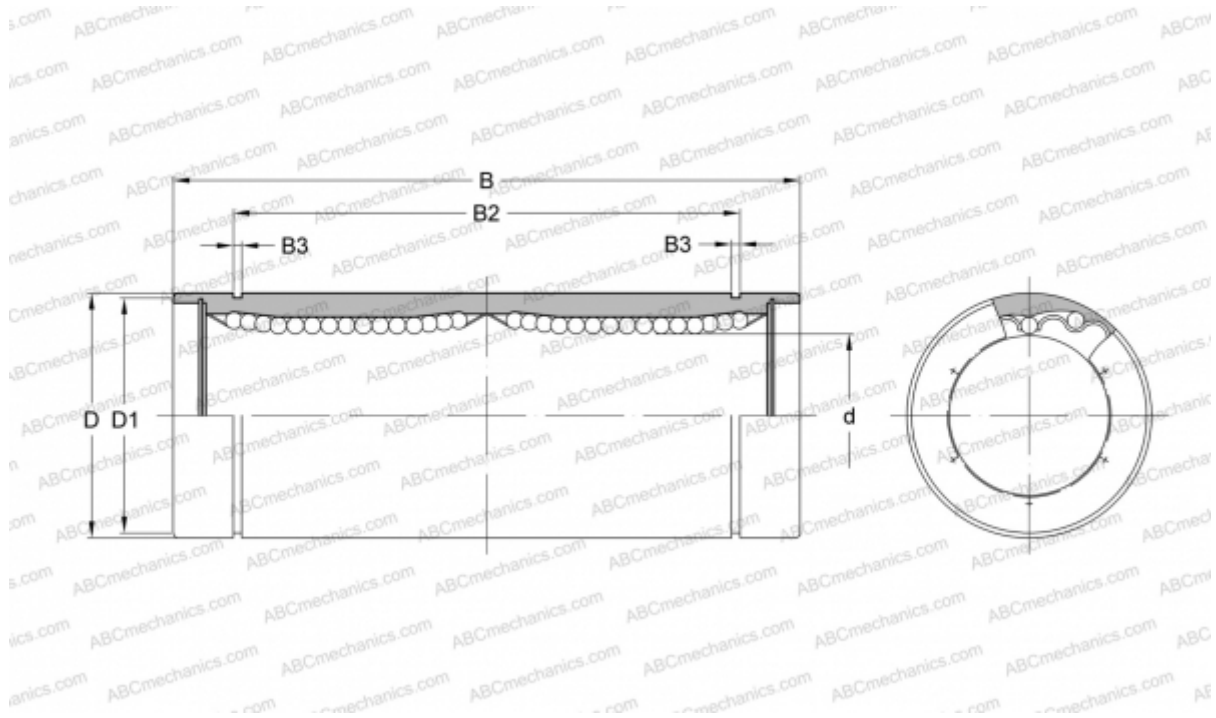

Technical specification

DIMENSIONS, MM

d	12,700
D	22,225
B	60,325
D1	20,853
B2	48,895
B3	1,168

WEIGHT, KG 0,080

MANUFACTURER [NB](#)