

SWS 10GW NB

Linear bushing

TYPE: Shaft guidance systems, Linear bushing, Standard, Close type, double length, Type SW..W, American standard, Corrosion resistance, Plastic cage (NB)

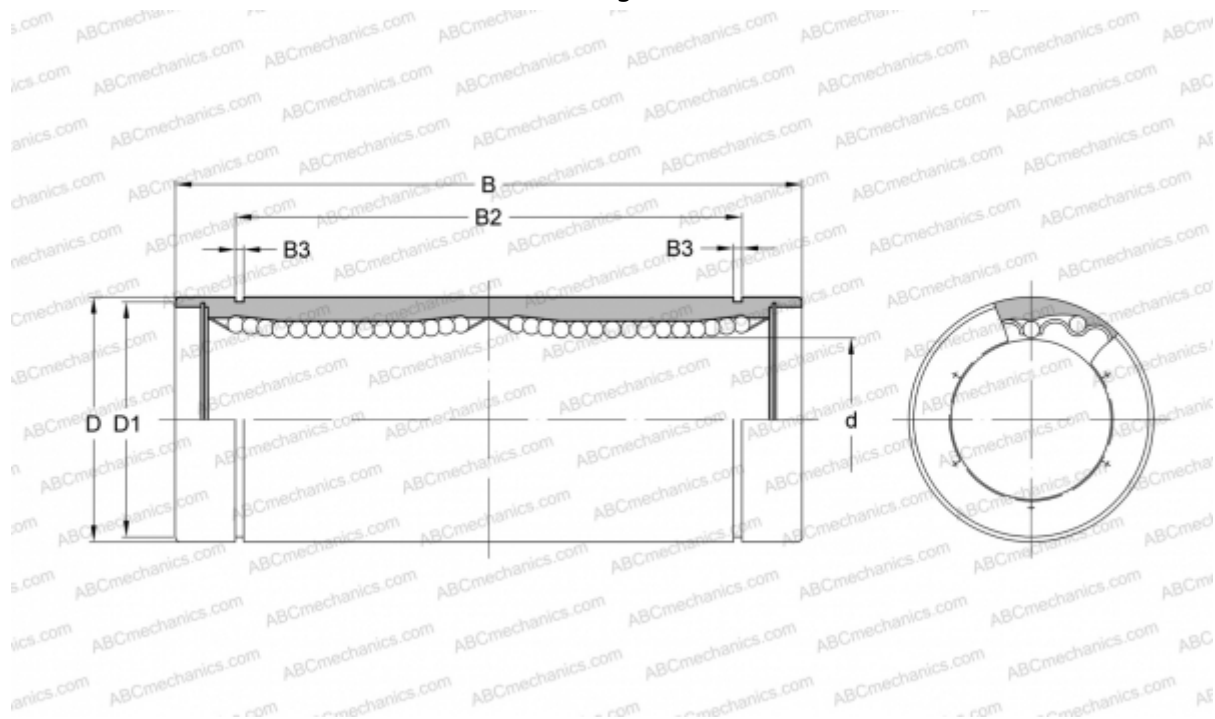

Technical specification

DIMENSIONS, MM

d	15,875
D	28,575
B	71,438
D1	26,899
B2	56,080
B3	1,422

WEIGHT, KG 0,160

MANUFACTURER [NB](#)