

SWS 16GW NB

Linear bushing

TYPE: Shaft guidance systems, Linear bushing, Standard, Close type, double length, Type SW..W, American standard, Corrosion resistance, Plastic cage (NB)

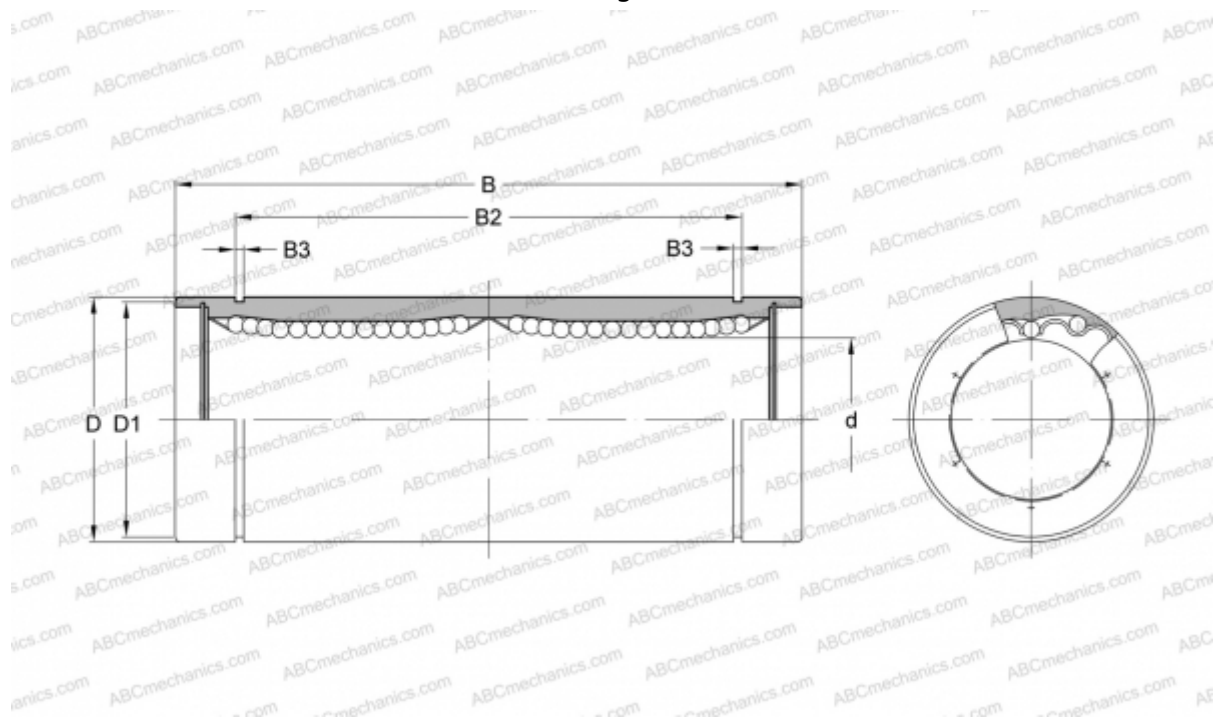

Technical specification

DIMENSIONS, MM

d	25,400
D	39,688
B	108,744
D1	37,306
B2	89,139
B3	1,727

WEIGHT, KG 0,410

MANUFACTURER [NB](#)