

SWF 40 NB

Linear bushing

TYPE: Shaft guidance systems, Linear bushing, With flange, Circular type, Type SWF, American standard, Steel cage (NB)

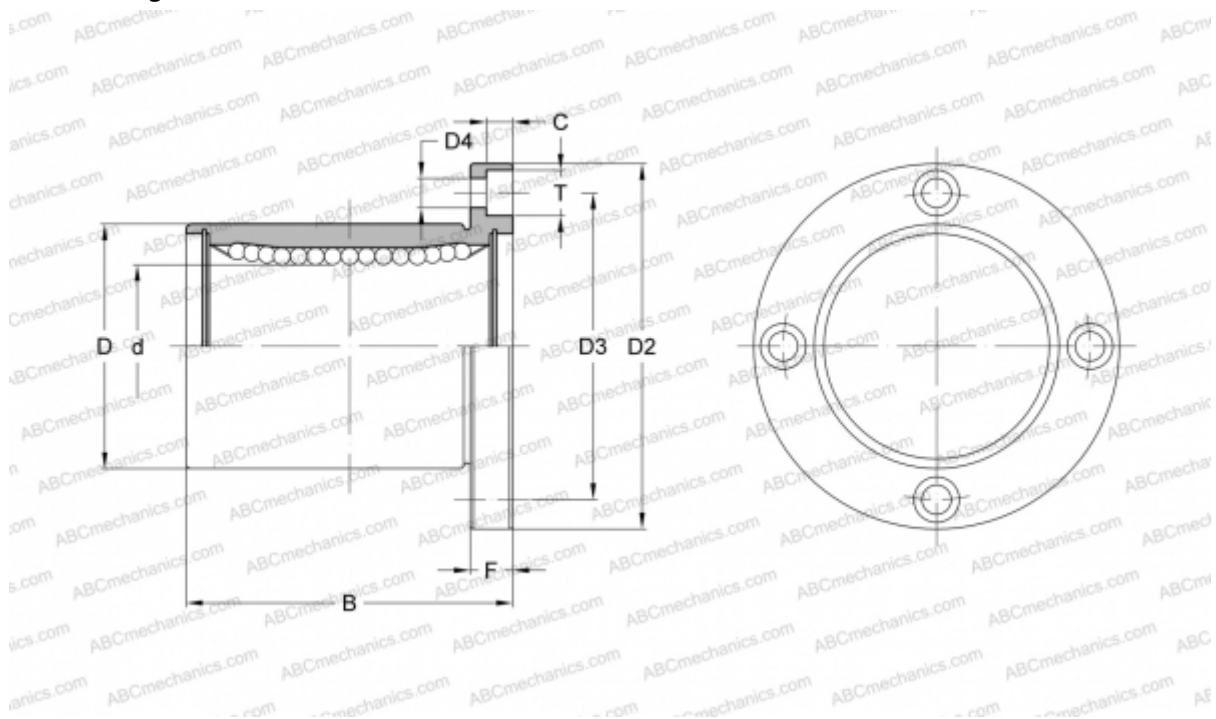

Technical specification

DIMENSIONS, MM

d	63,500
D	95,250
B	127,000
D2	136,525
D3	115,887
D4	10,319
T	15,875
C	9,525
F	19.05

WEIGHT, KG 3,570

MANUFACTURER [NB](#)