

SWF 8G NB

Linear bushing

TYPE: Shaft guidance systems, Linear bushing, With flange, Circular type, Type SWF, American standard, Plastic cage (NB)

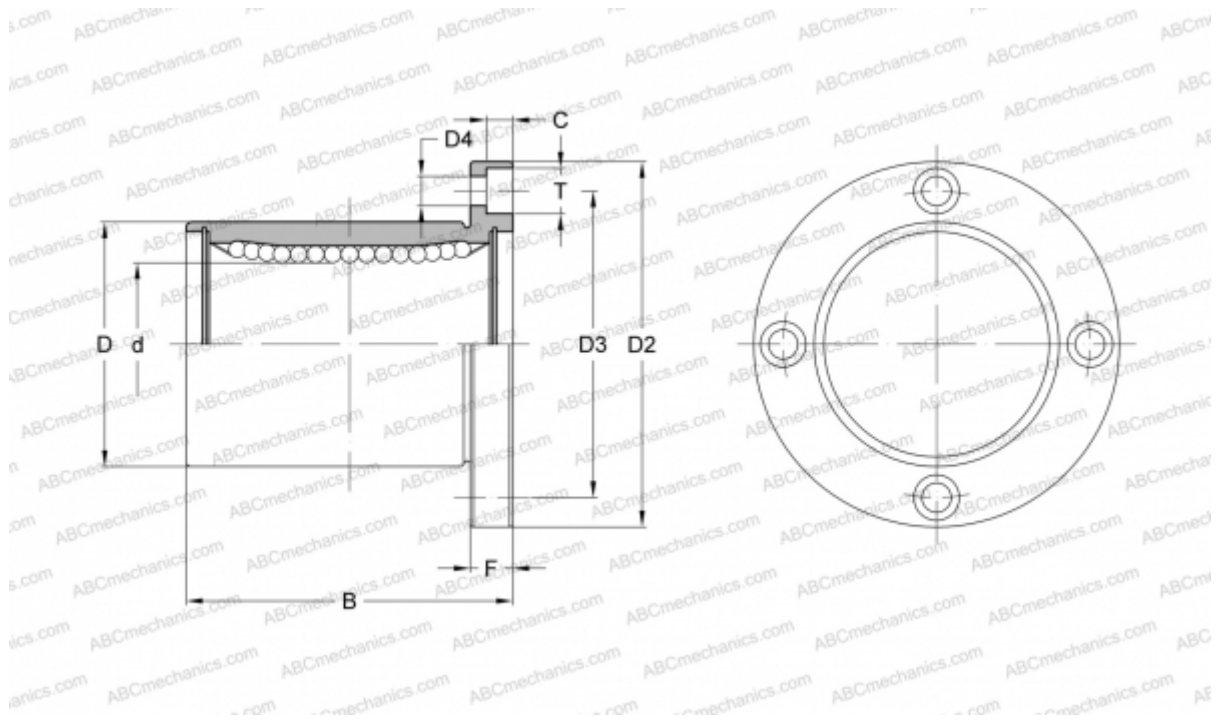

Technical specification

DIMENSIONS, MM

d	12,700
D	22,225
B	31,750
D2	44,450
D3	33,338
D4	4,763
T	7,541
C	4,366
F	6.35

WEIGHT, KG 0,088

MANUFACTURER [NB](#)