

## SWSF 4 NB

Linear bushing

TYPE: Shaft guidance systems, Linear bushing, With flange, Circular type, Type SWF, American standard, Corrosion resistance, Stainless steel cage (NB)

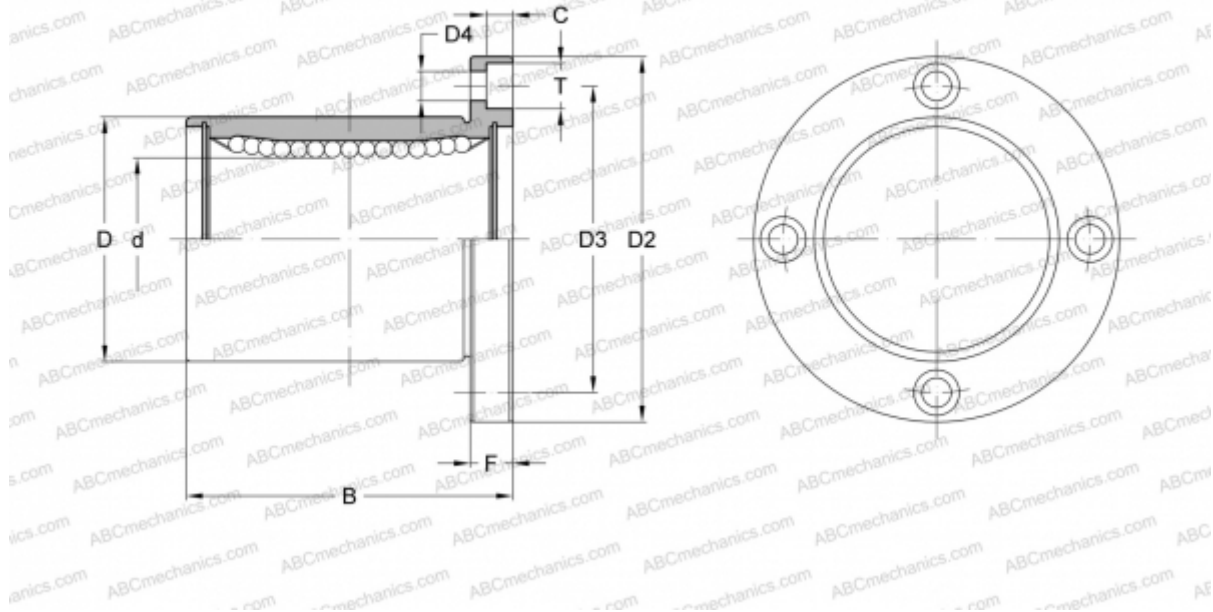

### Technical specification

#### DIMENSIONS, MM

d	6,350
D	12,700
B	19,050
D2	31,750
D3	22,225
D4	3,969
T	6,350
C	3,572
F	5.556

**WEIGHT, KG** 0,032

**MANUFACTURER** [NB](#)