

## SWSF 12 NB

Linear bushing

TYPE: Shaft guidance systems, Linear bushing, With flange, Circular type, Type SWF, American standard, Corrosion resistance, Stainless steel cage (NB)

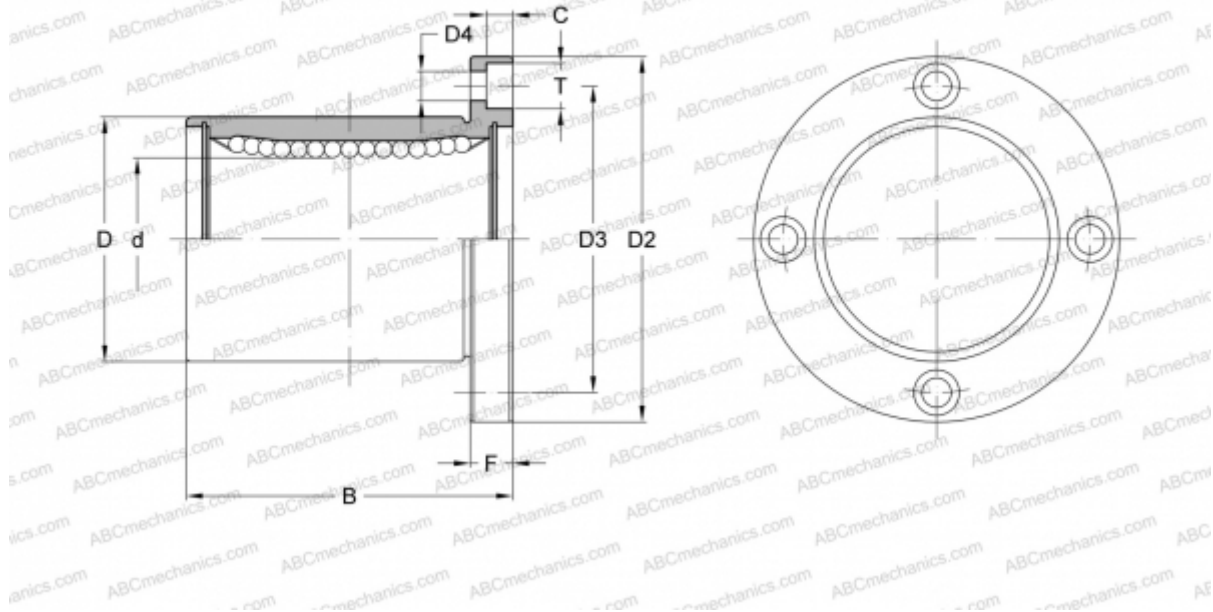

### Technical specification

#### DIMENSIONS, MM

d	19,050
D	31,750
B	41,275
D2	55,563
D3	43,660
D4	5,556
T	8,731
C	5,159
F	7.938

**WEIGHT, KG** 0,190

**MANUFACTURER** [NB](#)