

## SWSF 20G NB

Linear bushing

TYPE: Shaft guidance systems, Linear bushing, With flange, Circular type, Type SWF, American standard, Corrosion resistance, Plastic cage (NB)

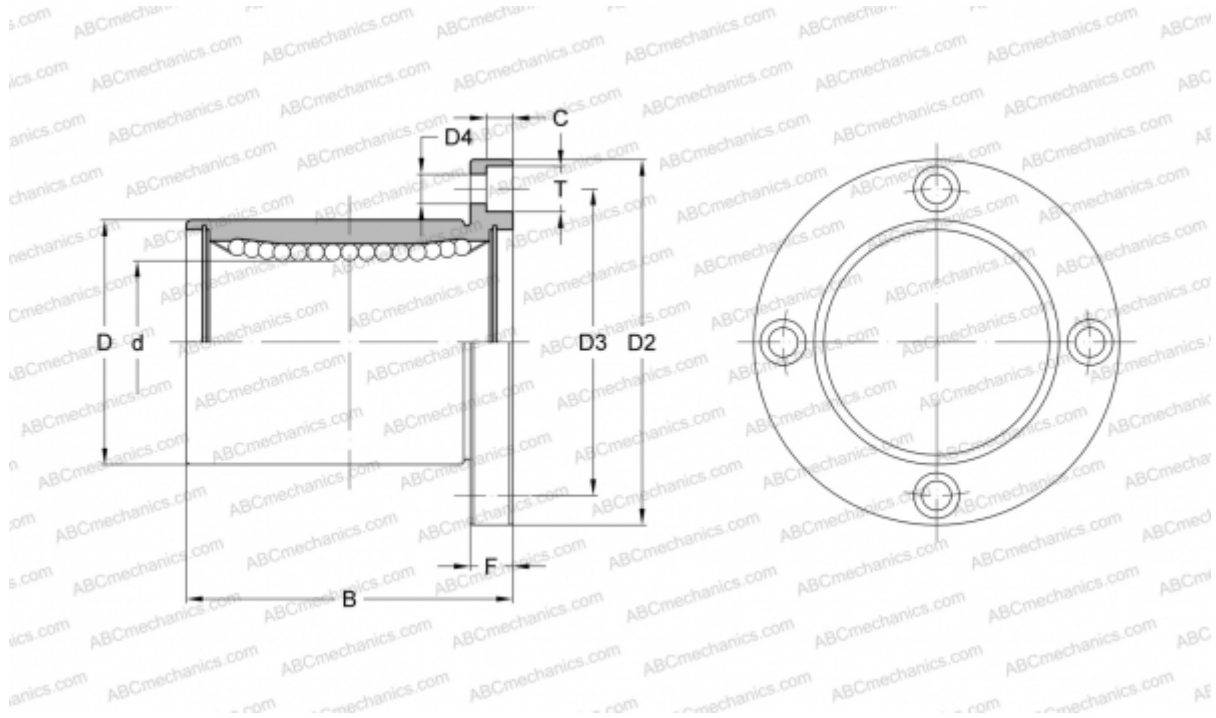

### Technical specification

#### DIMENSIONS, MM

d	31,750
D	50,800
B	66,675
D2	79,375
D3	65,088
D4	7,144
T	10,319
C	6,747
F	9.525

**WEIGHT, KG** 0,665

**MANUFACTURER** [NB](#)