

SWK 4 NB

Linear bushing

TYPE: Shaft guidance systems, Linear bushing, With flange, Square type, Type SWK, American standard, Steel cage (NB)

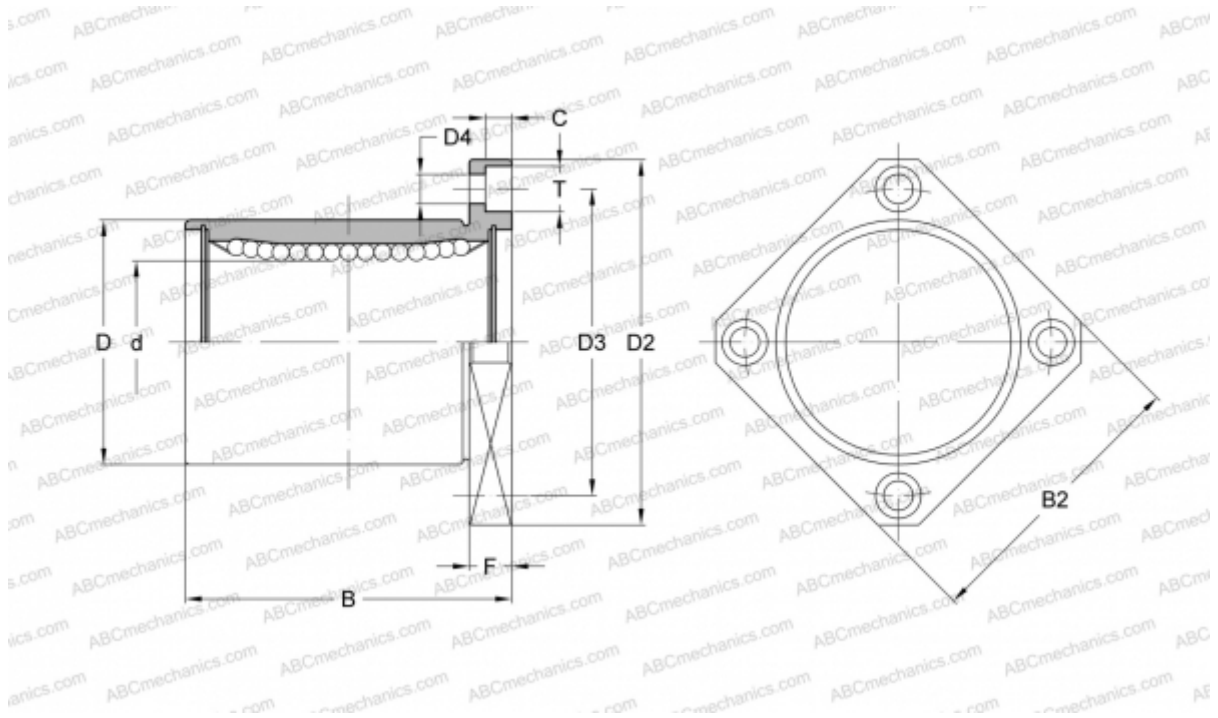

Technical specification

DIMENSIONS, MM

d	6,350
D	12,700
B	19,050
D2	31,750
D3	22,225
D4	3,969
B2	25,400
T	6,350
C	3,572
F	5,556

WEIGHT, KG 0,025

MANUFACTURER [NB](#)