

SWK 12 NB

Linear bushing

TYPE: Shaft guidance systems, Linear bushing, With flange, Square type, Type SWK, American standard, Steel cage (NB)

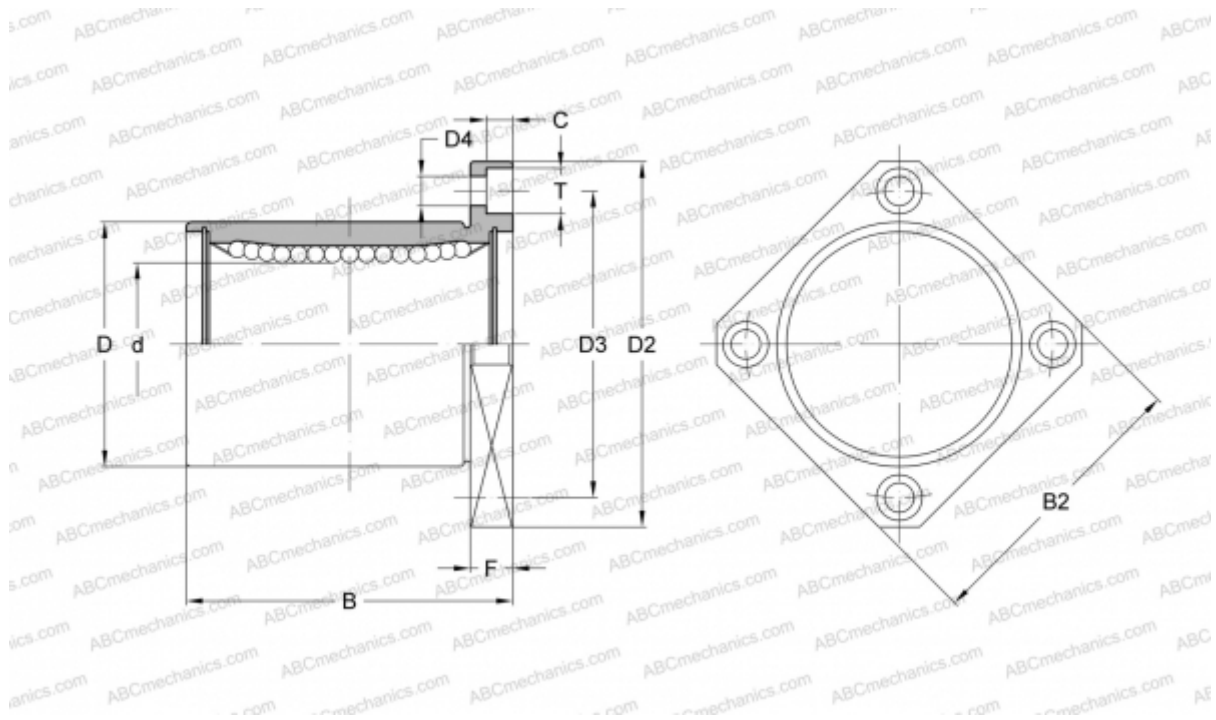

Technical specification

DIMENSIONS, MM

d	19,050
D	31,750
B	41,275
D2	55,563
D3	43,660
D4	5,556
B2	42,863
T	8,731
C	5,159
F	7,938

WEIGHT, KG 0,150

MANUFACTURER [NB](#)