

SWK 24 NB

Linear bushing

TYPE: Shaft guidance systems, Linear bushing, With flange, Square type, Type SWK, American standard, Steel cage (NB)

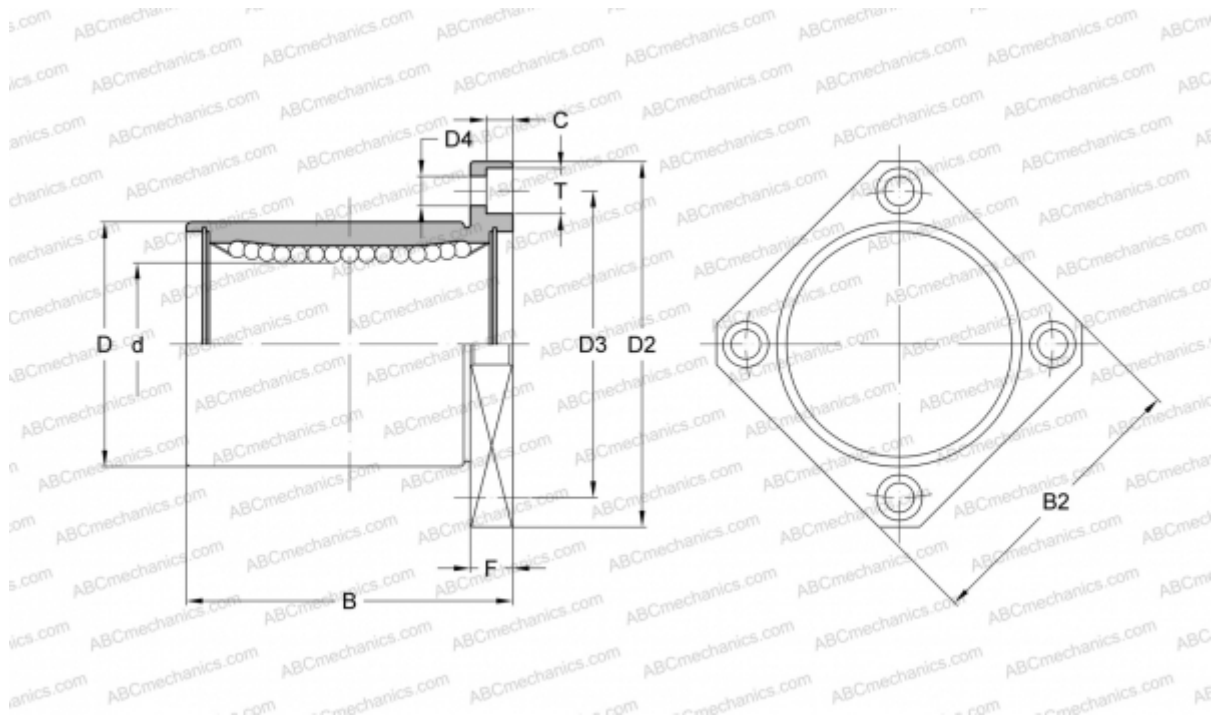

Technical specification

DIMENSIONS, MM

d	38,100
D	60,325
B	76,200
D2	95,250
D3	77,788
D4	8,731
B2	76,200
T	12,700
C	8,334
F	12.7

WEIGHT, KG 0,930

MANUFACTURER [NB](#)