

SWSK 6G NB

Linear bushing

TYPE: Shaft guidance systems, Linear bushing, With flange, Square type, Type SWK, American standard, Corrosion resistance, Plastic cage (NB)

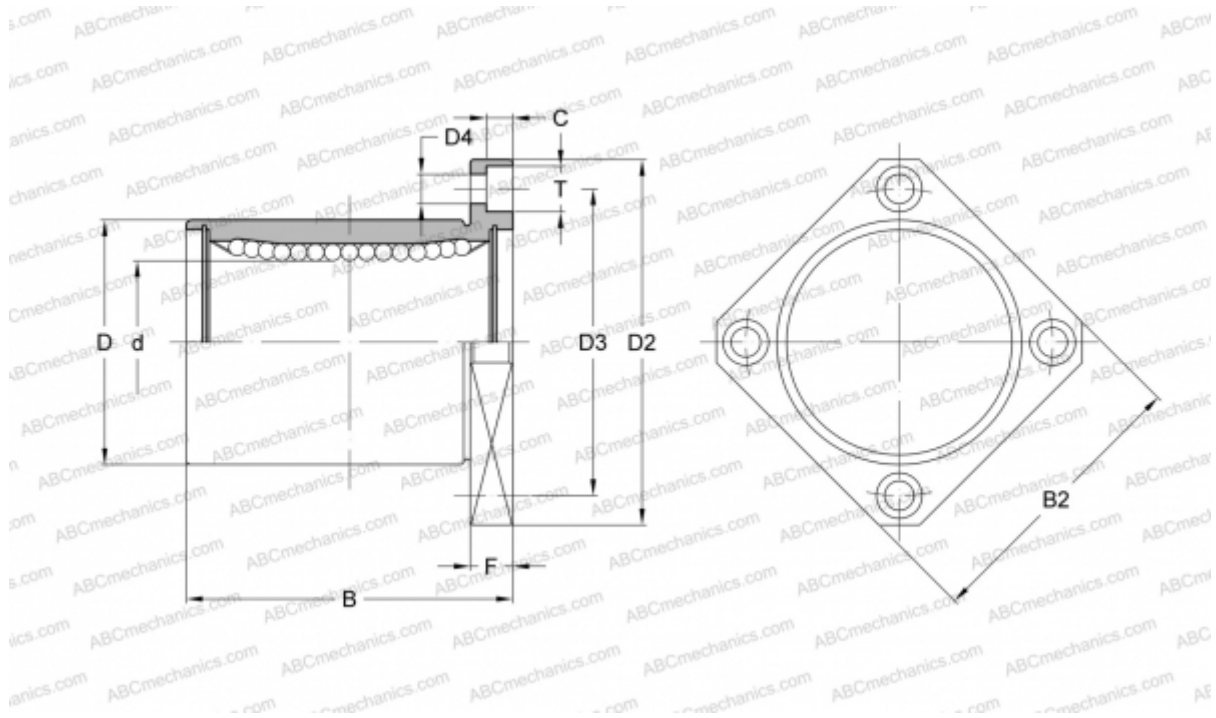

Technical specification

DIMENSIONS, MM

d	9,525
D	15,875
B	22,225
D2	38,100
D3	26,988
D4	4,763
B2	31,750
T	7,541
C	4,366
F	6.35

WEIGHT, KG 0,032

MANUFACTURER [NB](#)