

SWSK 10G NB

Linear bushing

TYPE: Shaft guidance systems, Linear bushing, With flange, Square type, Type SWK, American standard, Corrosion resistance, Plastic cage (NB)

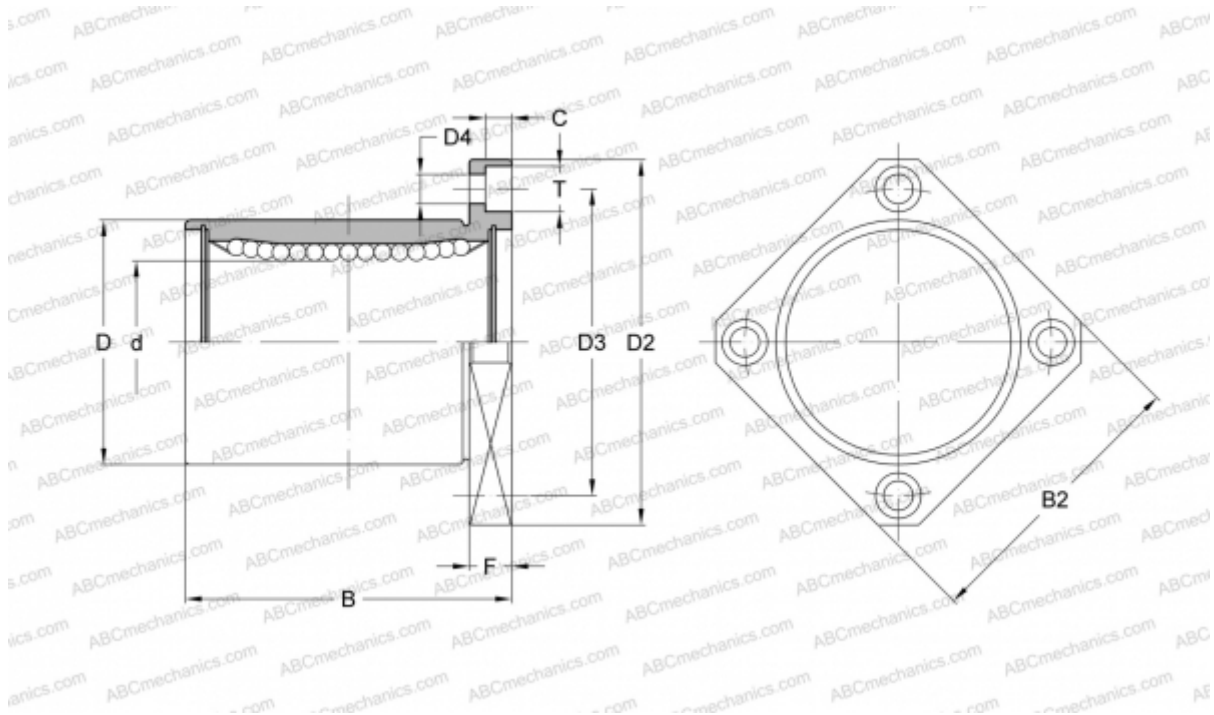

Technical specification

DIMENSIONS, MM

d	15,875
D	28,575
B	38,100
D2	50,800
D3	39,688
D4	4,763
B2	38,100
T	7,541
C	4,366
F	6.35

WEIGHT, KG 0,124

MANUFACTURER [NB](#)