

SWSK 20G NB

Linear bushing

TYPE: Shaft guidance systems, Linear bushing, With flange, Square type, Type SWK, American standard, Corrosion resistance, Plastic cage (NB)

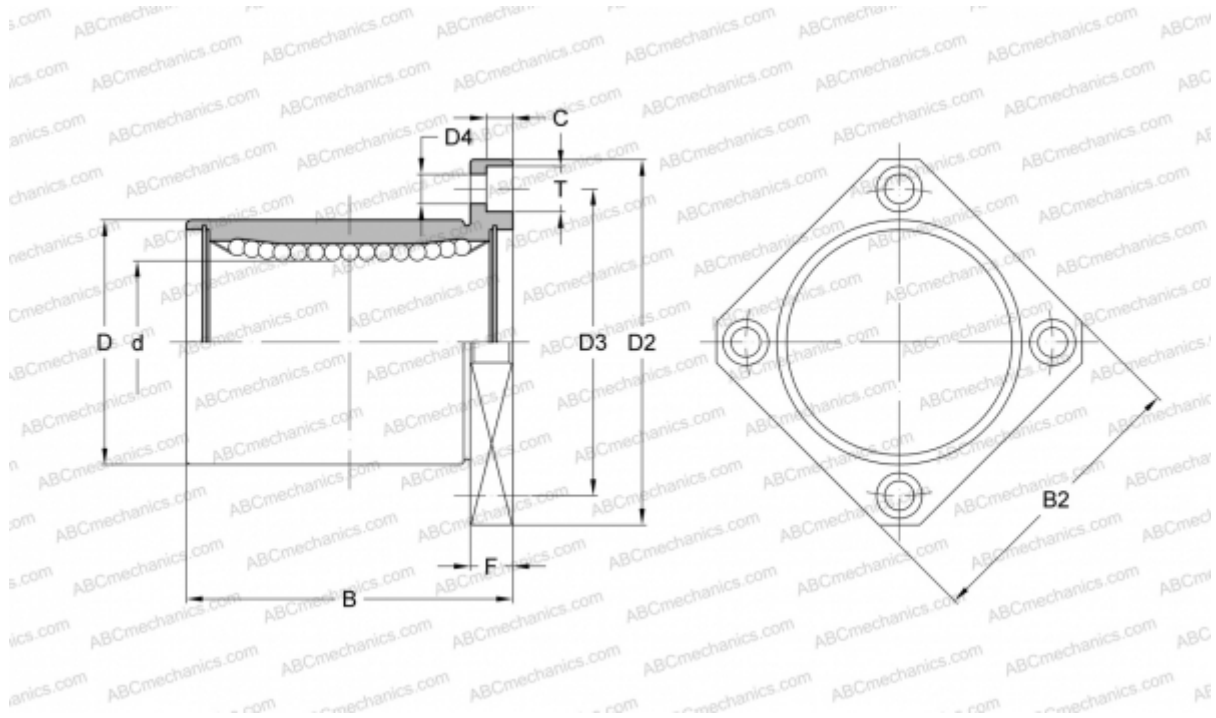

Technical specification

DIMENSIONS, MM

d	31,750
D	50,800
B	66,675
D2	79,375
D3	65,088
D4	7,144
B2	63,500
T	10,319
C	6,747
F	9.525

WEIGHT, KG 0,580

MANUFACTURER [NB](#)