

SWF 4GW NB

Linear bushing

TYPE: Shaft guidance systems, Linear bushing, With flange, Circular type, double length, Type SWF..W, American standard, Plastic cage (NB)

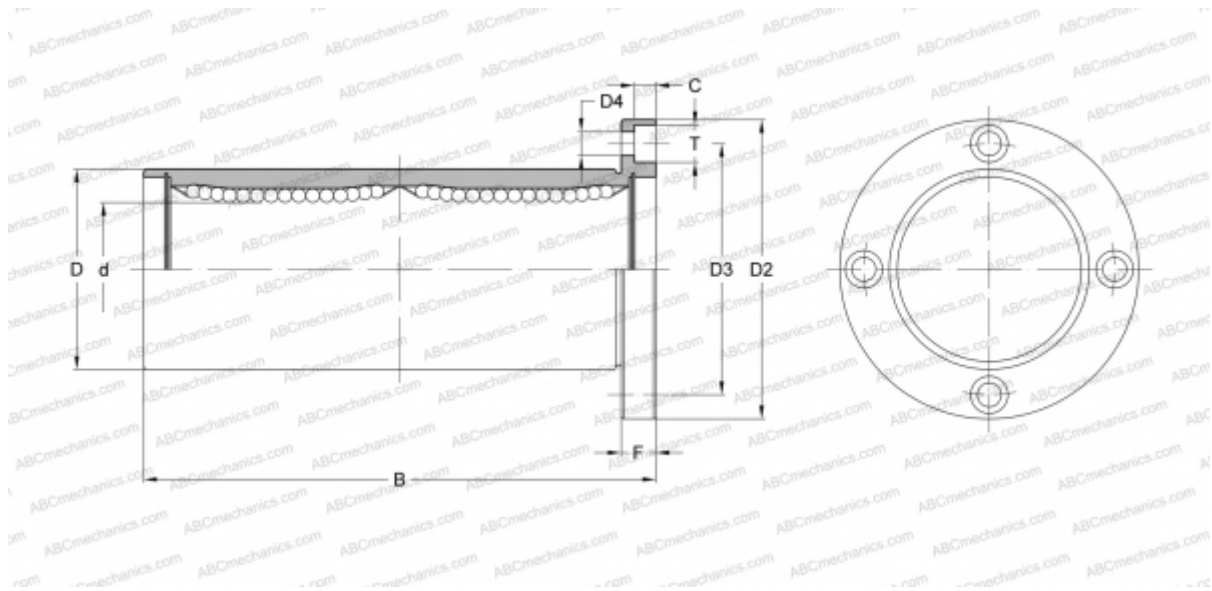

Technical specification

DIMENSIONS, MM

d	6,350
D	12,700
B	34,925
D2	31,750
D3	22,225
D4	3,969
T	6,350
C	3,572
F	5.556

WEIGHT, KG 0,040

MANUFACTURER [NB](#)