

## SWF 10GW NB

Linear bushing

TYPE: Shaft guidance systems, Linear bushing, With flange, Circular type, double length, Type SWF..W, American standard, Plastic cage (NB)

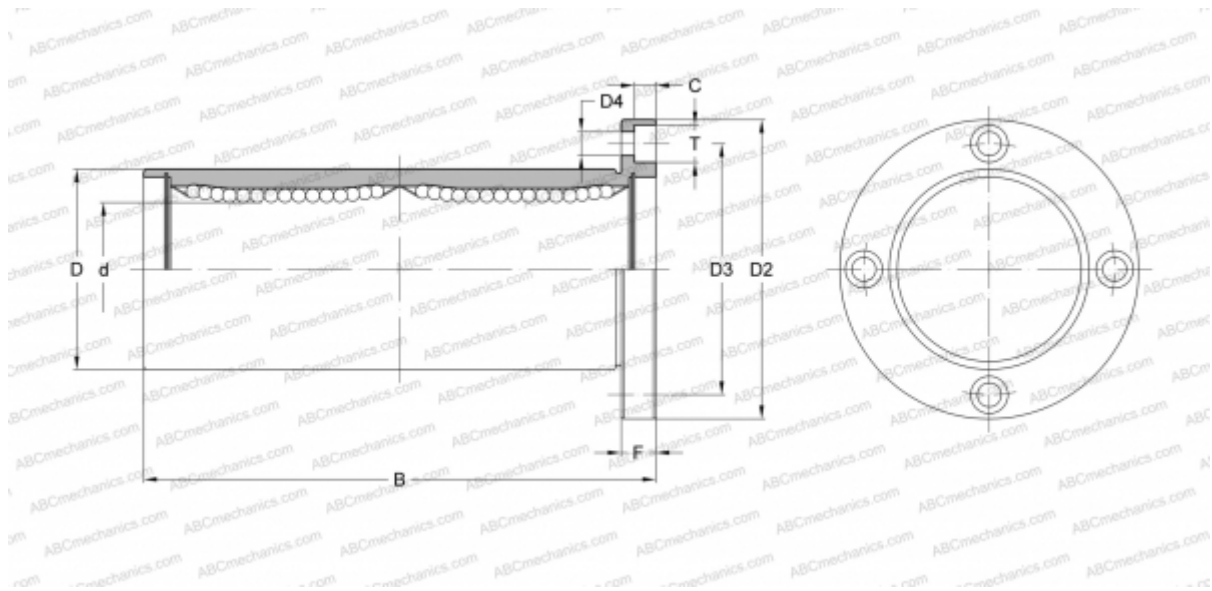

### Technical specification

#### DIMENSIONS, MM

d	15,875
D	28,575
B	71,438
D2	50,800
D3	39,688
D4	4,763
T	7,541
C	4,366
F	6.35

**WEIGHT, KG** 0,215

**MANUFACTURER** [NB](#)