

## SWSF 8GW NB

Linear bushing

TYPE: Shaft guidance systems, Linear bushing, With flange, Circular type, double length, Type SWF..W, American standard, Corrosion resistance, Plastic cage (NB)

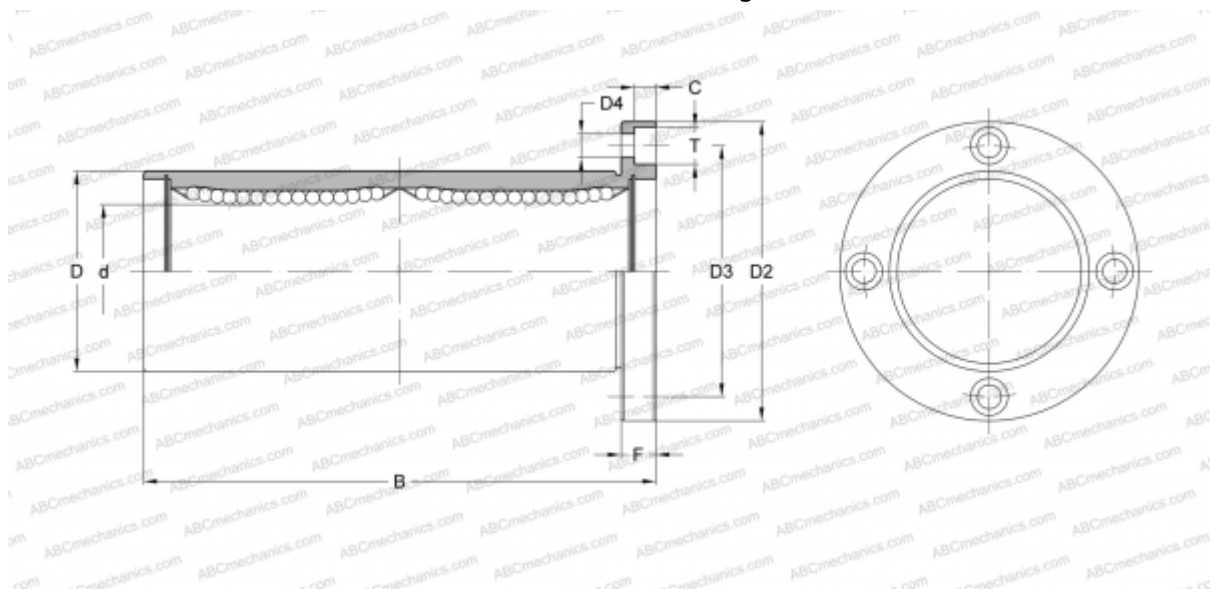

### Technical specification

#### DIMENSIONS, MM

d	12,700
D	22,225
B	60,325
D2	44,450
D3	33,338
D4	4,763
T	7,541
C	4,366
F	6.35

**WEIGHT, KG** 0,126

**MANUFACTURER** [NB](#)