

SWK 8W NB

Linear bushing

TYPE: Shaft guidance systems, Linear bushing, With flange, Square type, double length, Type SWK..W, American standard, Steel cage (NB)

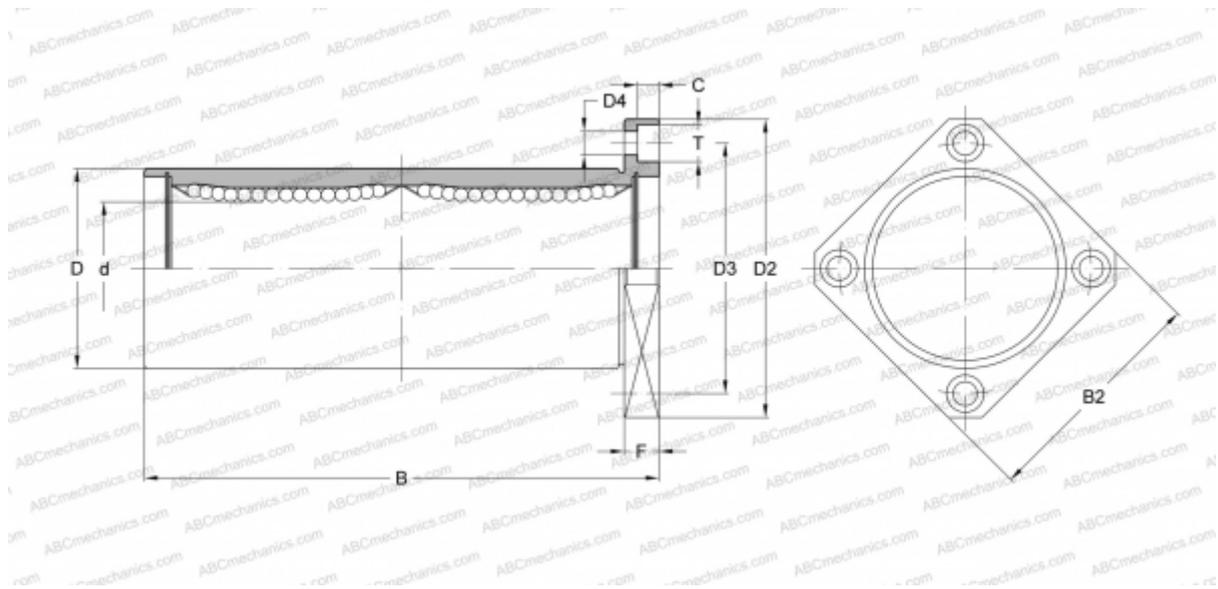

Technical specification

DIMENSIONS, MM

d	12,700
D	22,225
B	60,325
D2	44,450
D3	33,338
D4	4,763
B2	34,925
T	7,541
C	4,366
F	6.35

WEIGHT, KG 0,106

MANUFACTURER [NB](#)