

## SWK 32GW NB

Linear bushing

TYPE: Shaft guidance systems, Linear bushing, With flange, Square type, double length, Type SWK..W, American standard, Plastic cage (NB)

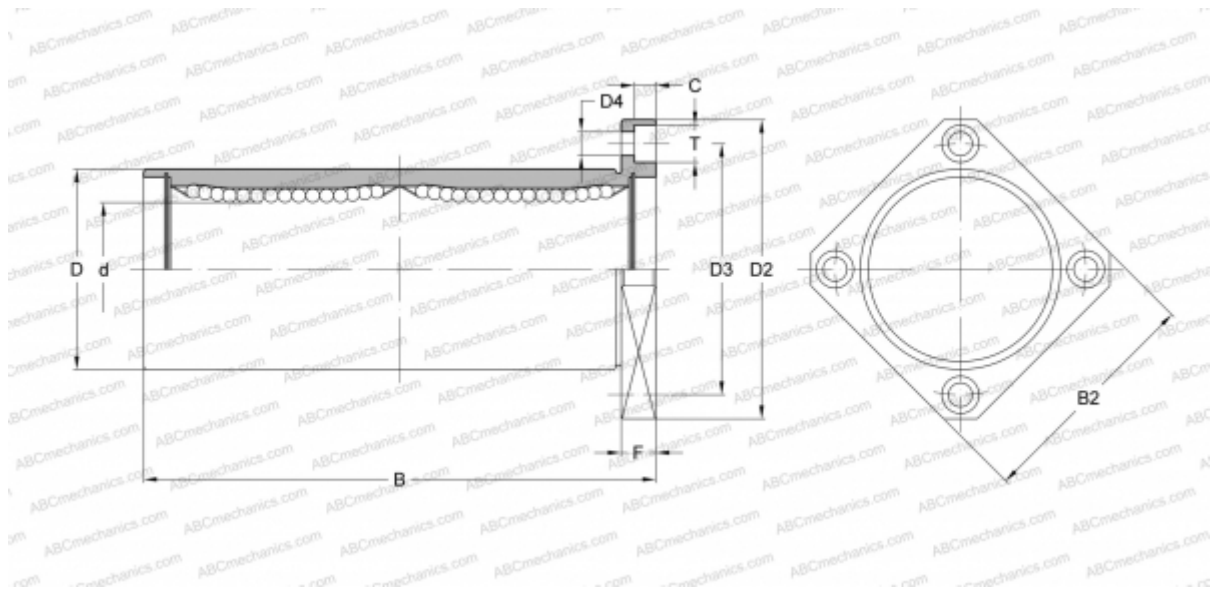

### Technical specification

#### DIMENSIONS, MM

d	50,800
D	76,200
B	196,850
D2	111,125
D3	93,662
D4	8,731
B2	88,900
T	12,700
C	8,334
F	12.7

**WEIGHT, KG** 2,620

**MANUFACTURER** [NB](#)