

SWSK 32W NB

Linear bushing

TYPE: Shaft guidance systems, Linear bushing, With flange, Square type, double length, Type SWK..W, American standard, Corrosion resistance, Stainless steel cage (NB)

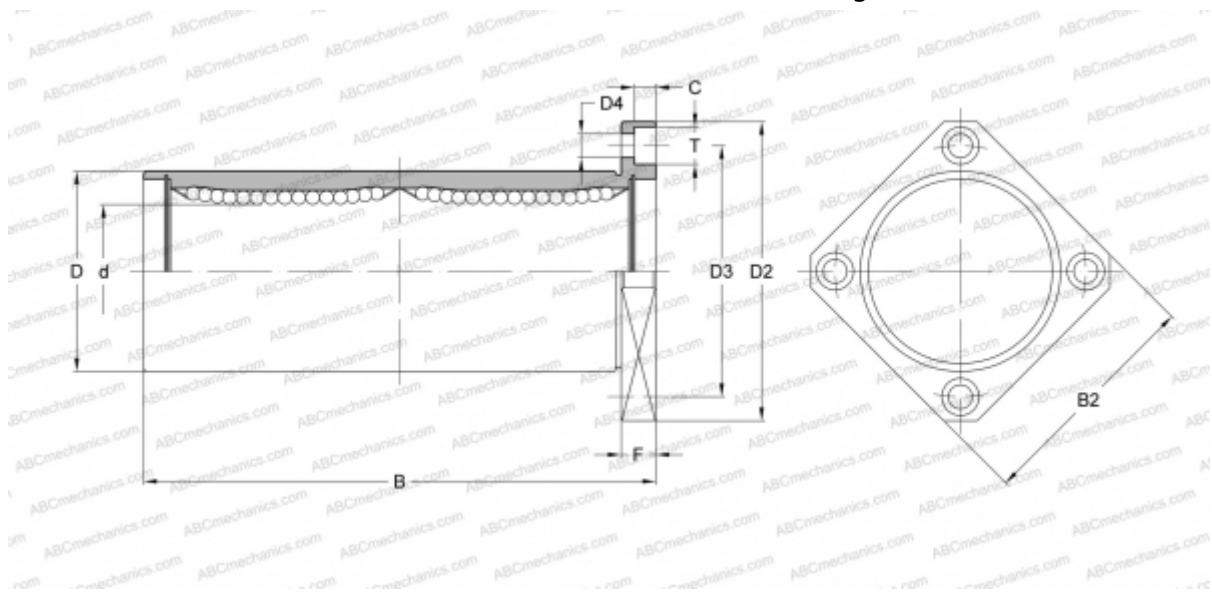

Technical specification

DIMENSIONS, MM

d	50,800
D	76,200
B	196,850
D2	111,125
D3	93,662
D4	8,731
B2	88,900
T	12,700
C	8,334
F	12.7

WEIGHT, KG 2,620

MANUFACTURER [NB](#)