

GM 6 NB

Linear bushing

TYPE: Shaft guidance systems, Linear bushing, Standard, Close type, Type GM (NB)

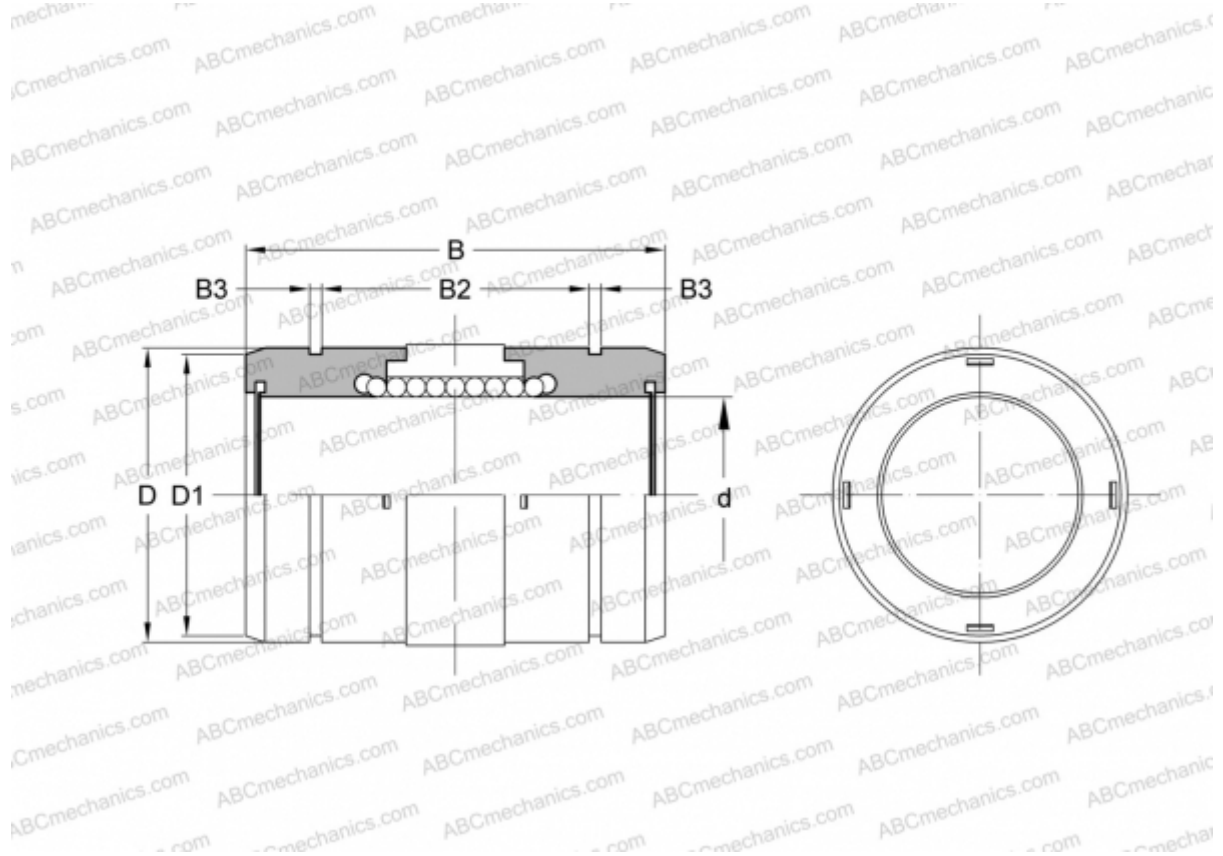

Technical specification

DIMENSIONS, MM

d	6,000
D	12,000
B	19,000
D1	11,500
B2	11,300
B3	1,100

WEIGHT, KG 0,005

MANUFACTURER [NB](#)