

GM 8 NB

Linear bushing

TYPE: Shaft guidance systems, Linear bushing, Standard, Close type, Type GM (NB)

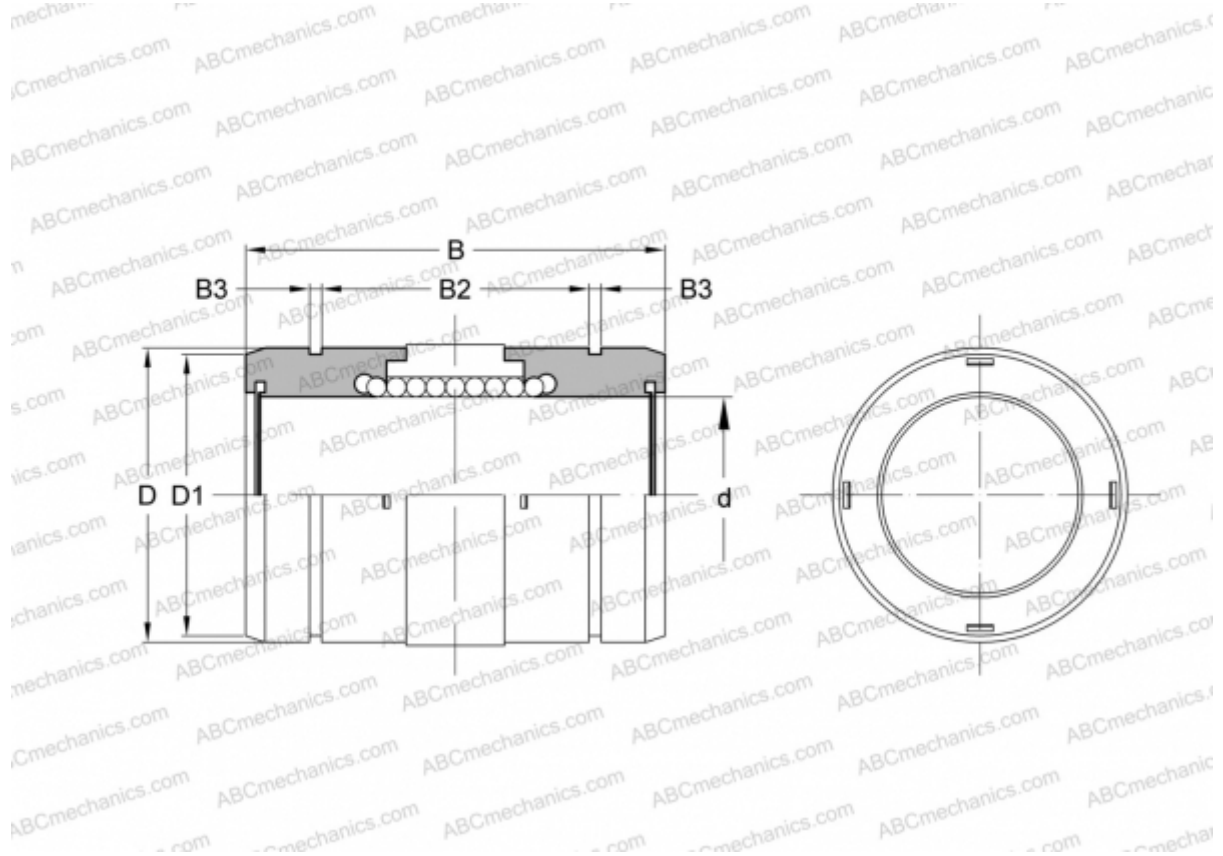

Technical specification

DIMENSIONS, MM

d	8,000
D	15,000
B	24,000
D1	14,300
B2	15,300
B3	1,100

WEIGHT, KG 0,010

MANUFACTURER [NB](#)