

## GM 12 NB

Linear bushing

TYPE: Shaft guidance systems, Linear bushing, Standard, Close type, Type GM (NB)

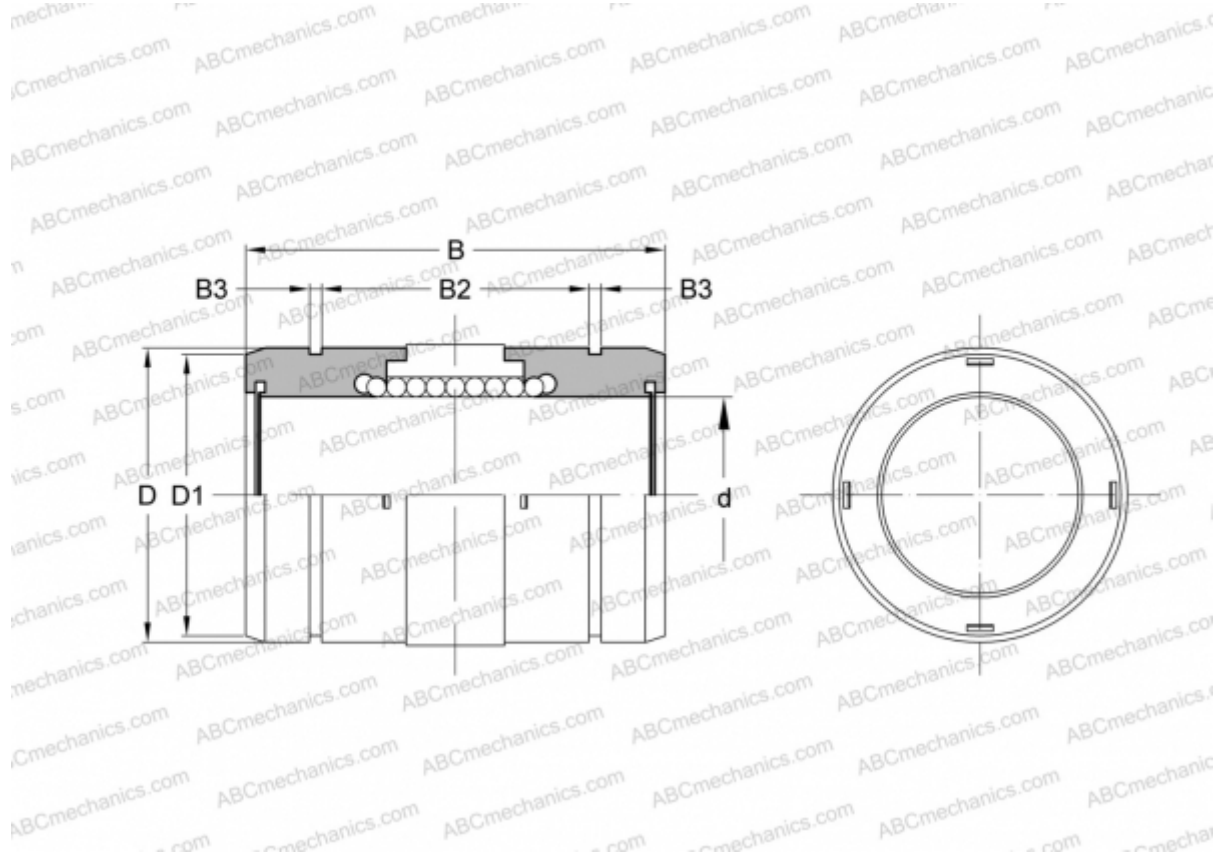

### Technical specification

#### DIMENSIONS, MM

d	12,000
D	21,000
B	30,000
D1	20,000
B2	20,400
B3	1,300

**WEIGHT, KG** 0,023

**MANUFACTURER** [NB](#)