

## GM 16 NB

Linear bushing

TYPE: Shaft guidance systems, Linear bushing, Standard, Close type, Type GM (NB)

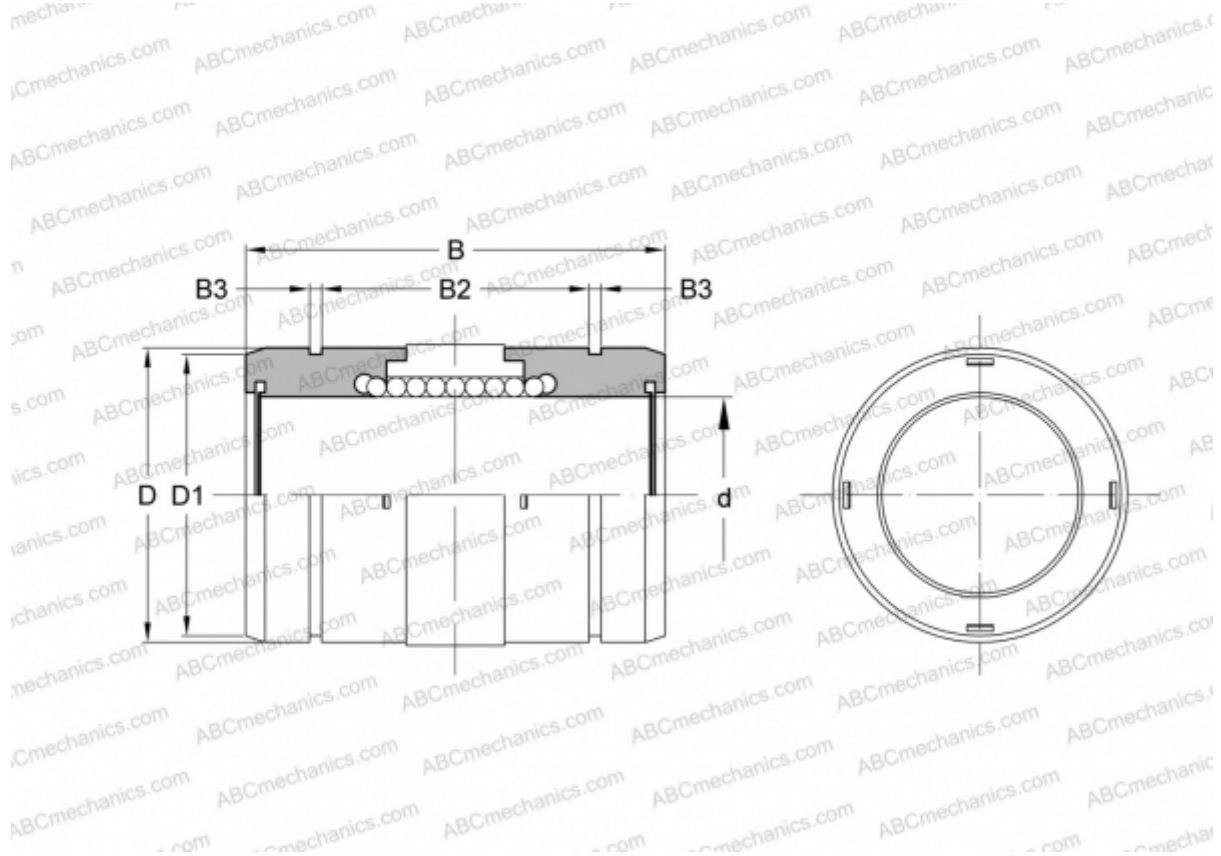

### Technical specification

#### DIMENSIONS, MM

d	16,000
D	28,000
B	37,000
D1	27,000
B2	23,300
B3	1,600

**WEIGHT, KG** 0,045

**MANUFACTURER** [NB](#)