

## GM 20 NB

Linear bushing

TYPE: Shaft guidance systems, Linear bushing, Standard, Close type, Type GM (NB)

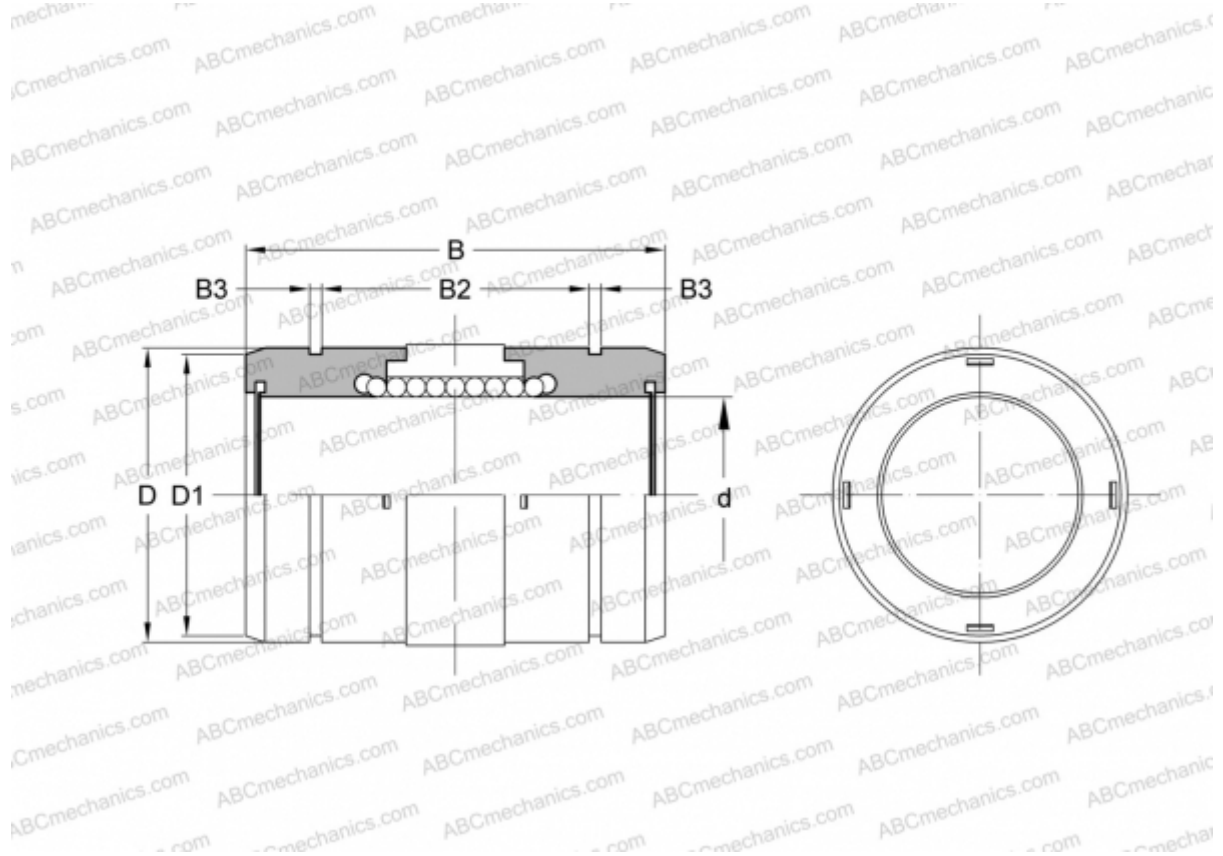

### Technical specification

#### DIMENSIONS, MM

d	20,000
D	32,000
B	42,000
D1	30,500
B2	27,300
B3	1,600

**WEIGHT, KG** 0,070

**MANUFACTURER** [NB](#)