

GM 30W UU NB

Linear bushing

TYPE: Shaft guidance systems, Linear bushing, Standard, Close type, double length, Type GM..W (NB)

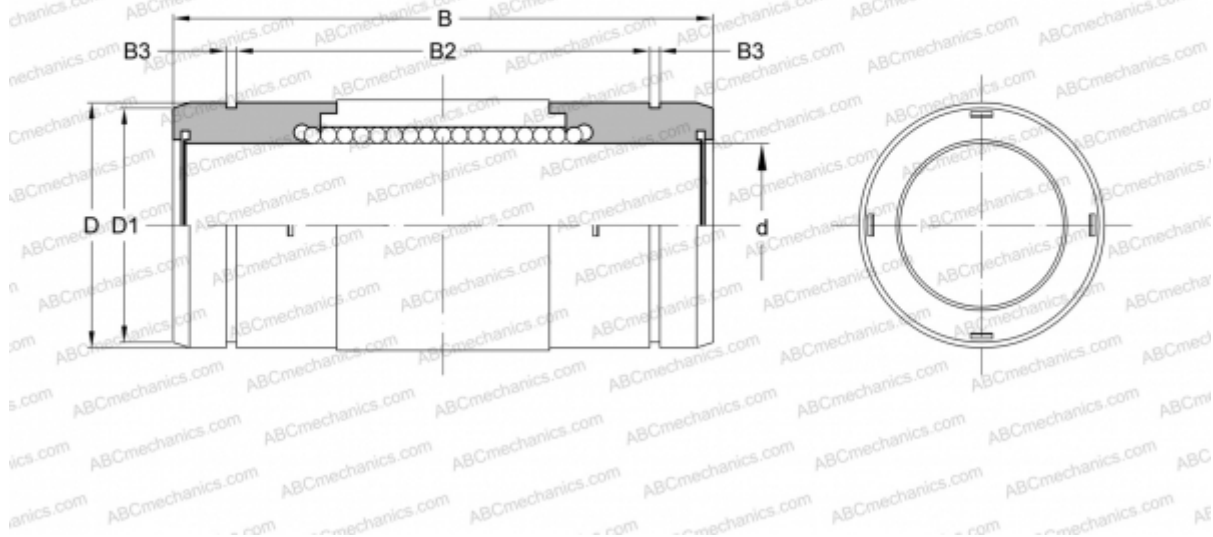

Technical specification

DIMENSIONS, MM

d	30,000
D	45,000
B	99,000
D1	43,000
B2	75,800
B3	1,850

WEIGHT, KG 0,334

MANUFACTURER [NB](#)