

## GW 12 NB

Linear bushing

TYPE: Shaft guidance systems, Linear bushing, Standard, Close type, Type GW, American standard (NB)

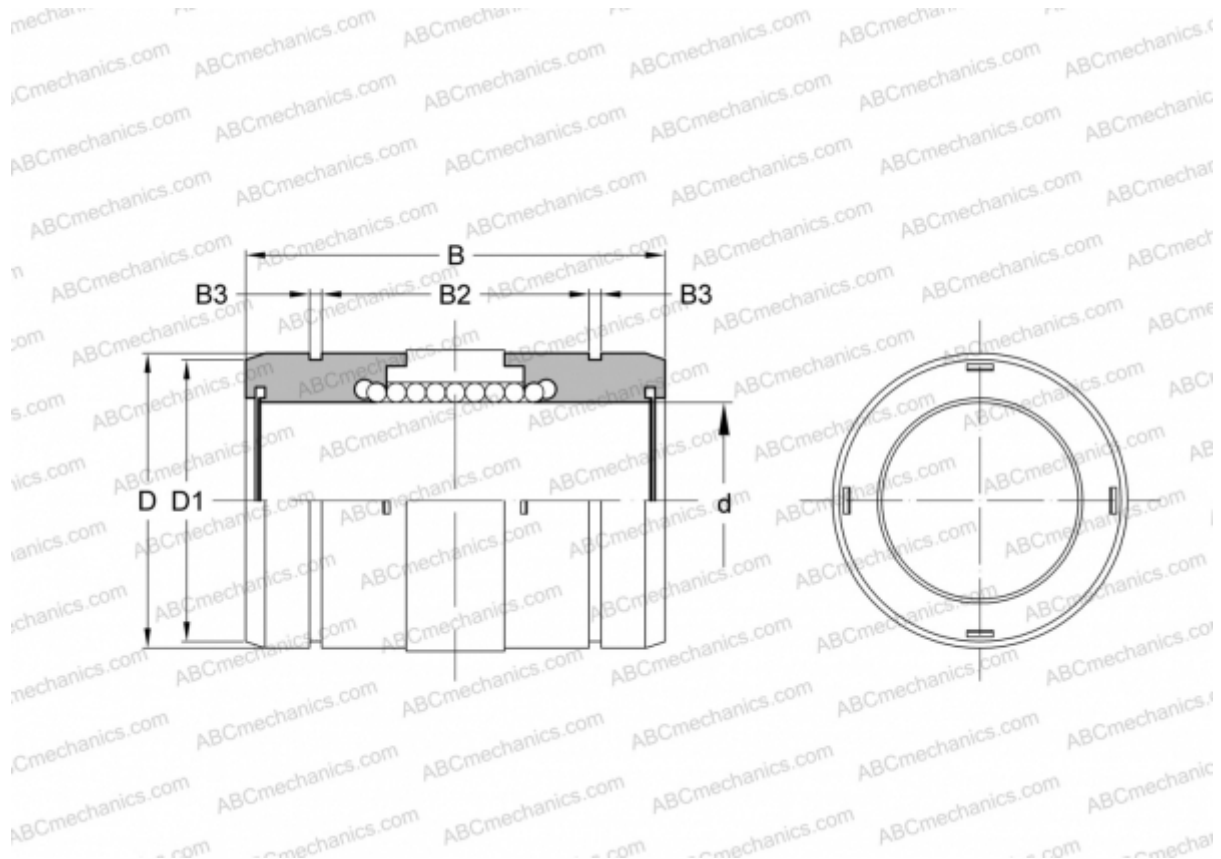

### Technical specification

#### DIMENSIONS, MM

d	19,050
D	31,750
B	41,275
D1	29,870
B2	26,767
B3	1,422

**WEIGHT, KG** 0,072

**MANUFACTURER** [NB](#)