

LMES10 UU SAMICK

Linear bushing

TYPE: Shaft guidance systems, Linear bushing, Self aligning, Close type, Type LMES, European standard (SAMICK)

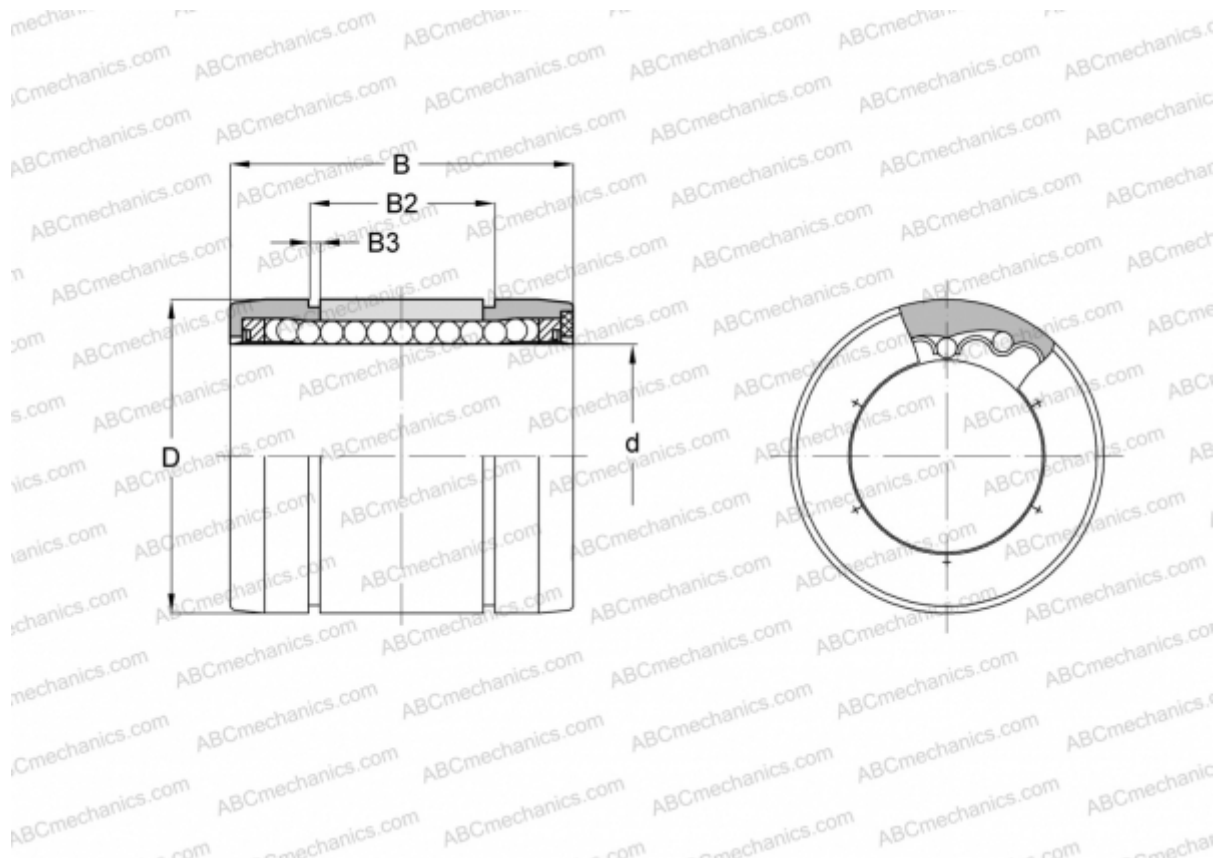

Technical specification

DIMENSIONS, MM

d	10,000
D	19,000
B	29,000
B2	21,700
B3	1,350

WEIGHT, KG 0,017

MANUFACTURER [SAMICK](http://www.samick.com)