

LMES12 UU SAMICK

Linear bushing

TYPE: Shaft guidance systems, Linear bushing, Self aligning, Close type, Type LMES, European standard (SAMICK)

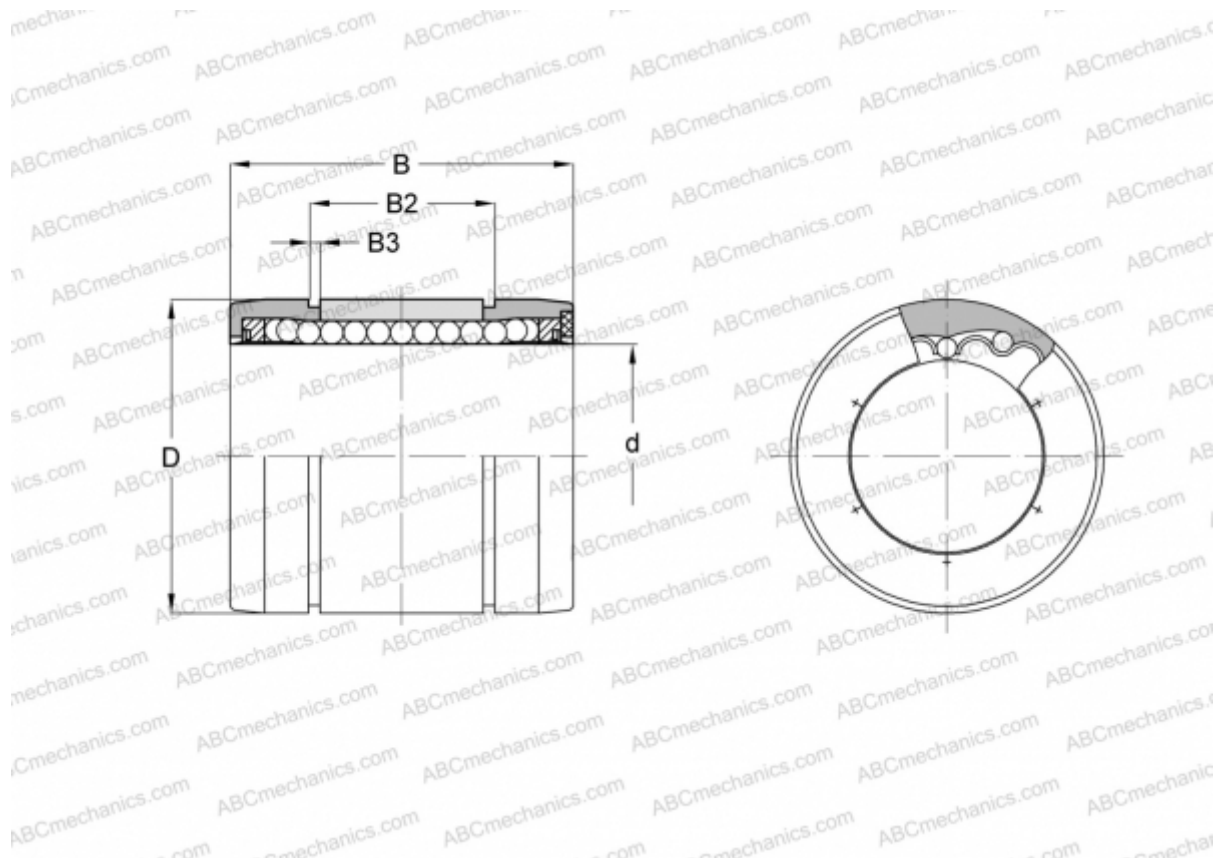

Technical specification

DIMENSIONS, MM

d	12,000
D	22,000
B	32,000
B2	22,700
B3	1,350

WEIGHT, KG 0,023

MANUFACTURER [SAMICK](http://www.samick.com)