

## LMES20 UU SAMICK

Linear bushing

TYPE: Shaft guidance systems, Linear bushing, Self aligning, Close type, Type LMES, European standard (SAMICK)

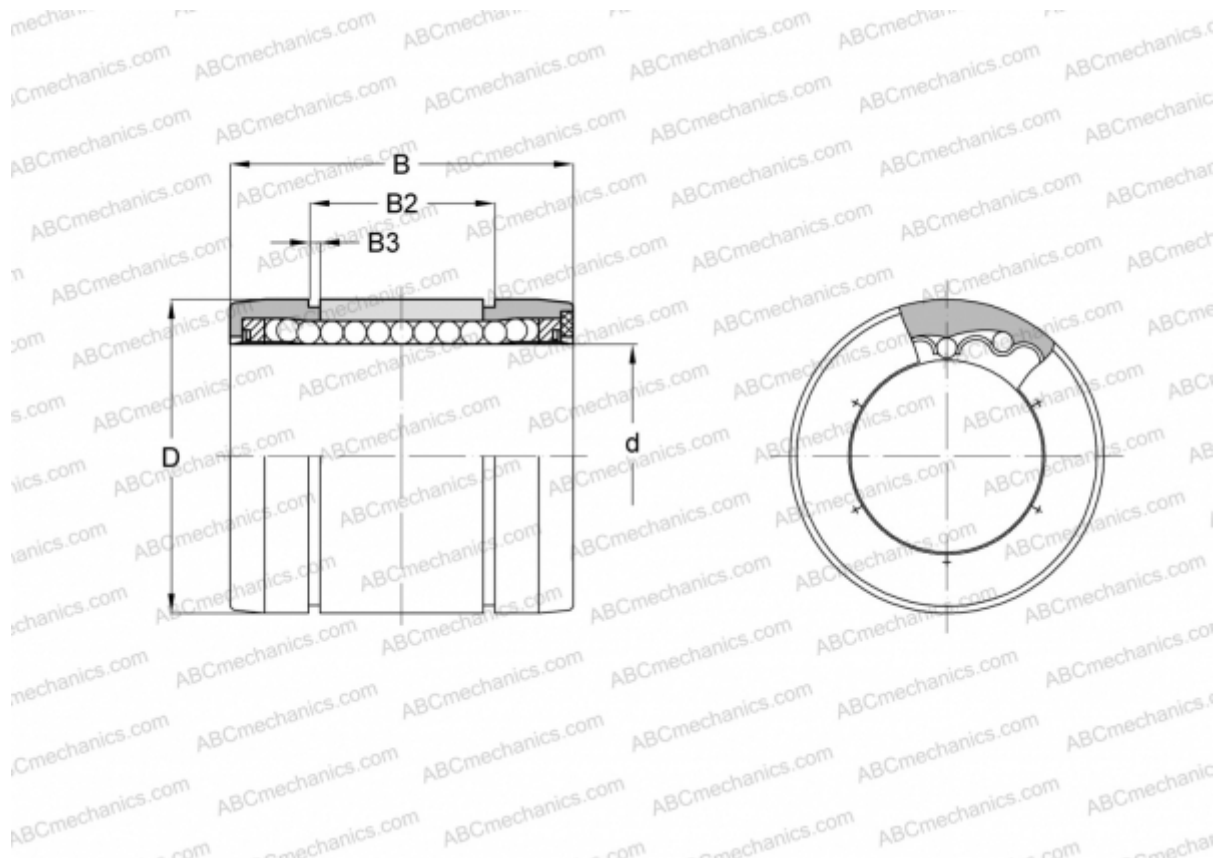

### Technical specification

#### DIMENSIONS, MM

d	20,000
D	32,000
B	45,000
B2	31,300
B3	1,650

**WEIGHT, KG** 0,061

**MANUFACTURER** [SAMICK](http://www.samick.com)