

LMES25 UU SAMICK

Linear bushing

TYPE: Shaft guidance systems, Linear bushing, Self aligning, Close type, Type LMES, European standard (SAMICK)

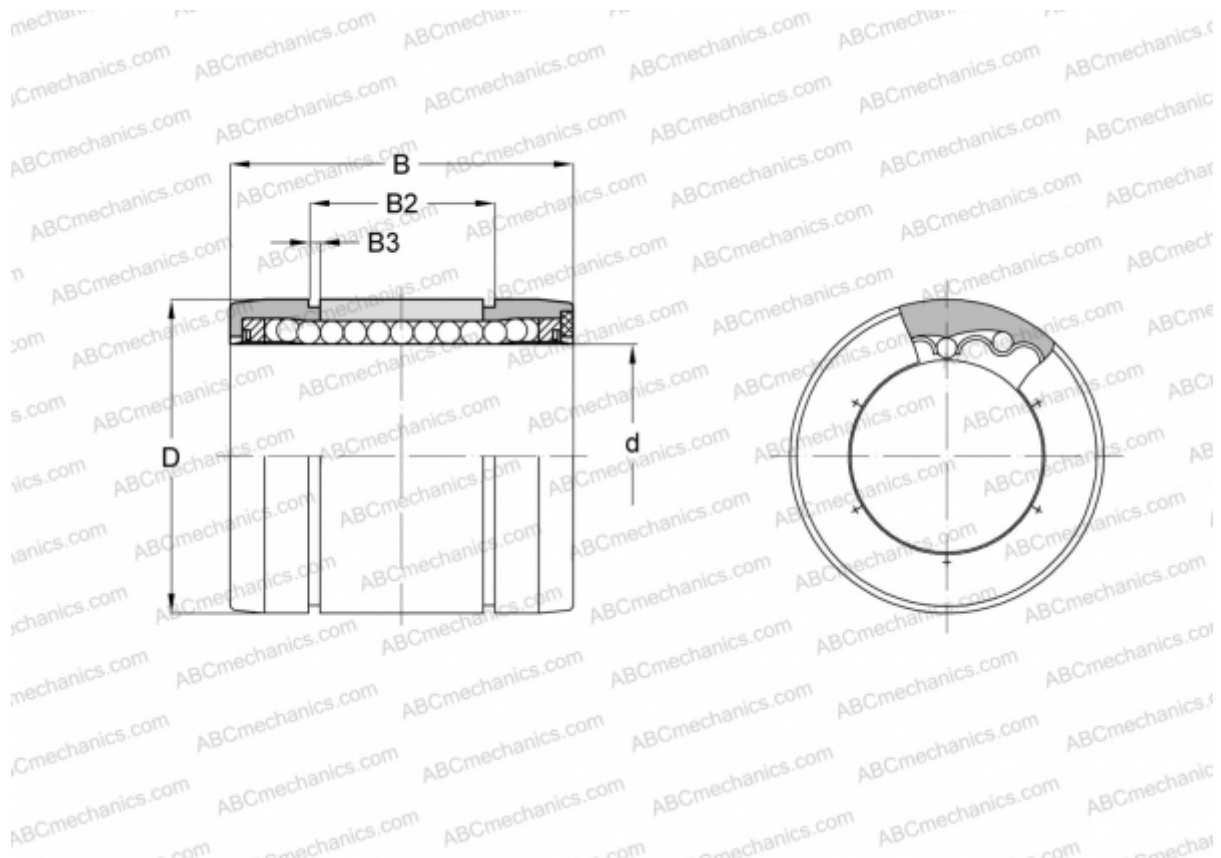

Technical specification

DIMENSIONS, MM

d	25,000
D	40,000
B	58,000
B2	43,800
B3	1,900

WEIGHT, KG 0,122

MANUFACTURER [SAMICK](http://www.samick.com)