

## LMES40 UU SAMICK

Linear bushing

TYPE: Shaft guidance systems, Linear bushing, Self aligning, Close type, Type LMES, European standard (SAMICK)

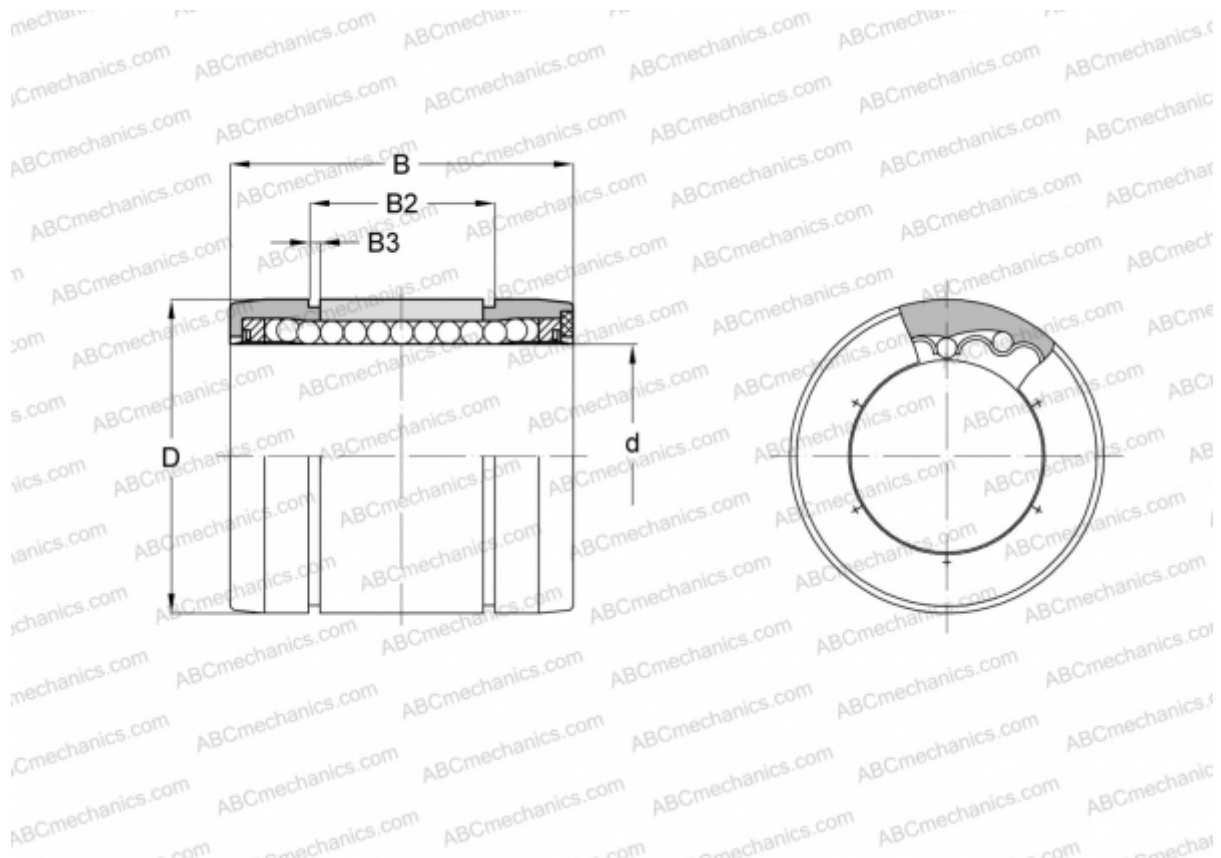

### Technical specification

#### DIMENSIONS, MM

d	40,000
D	62,000
B	80,000
B2	60,400
B3	2,200

**WEIGHT, KG** 0,360

**MANUFACTURER** [SAMICK](http://www.samick.com)