

LMBS8 UU SAMICK

Linear bushing

TYPE: Shaft guidance systems, Linear bushing, Self aligning, Close type, Type LMBS, American standard (SAMICK)

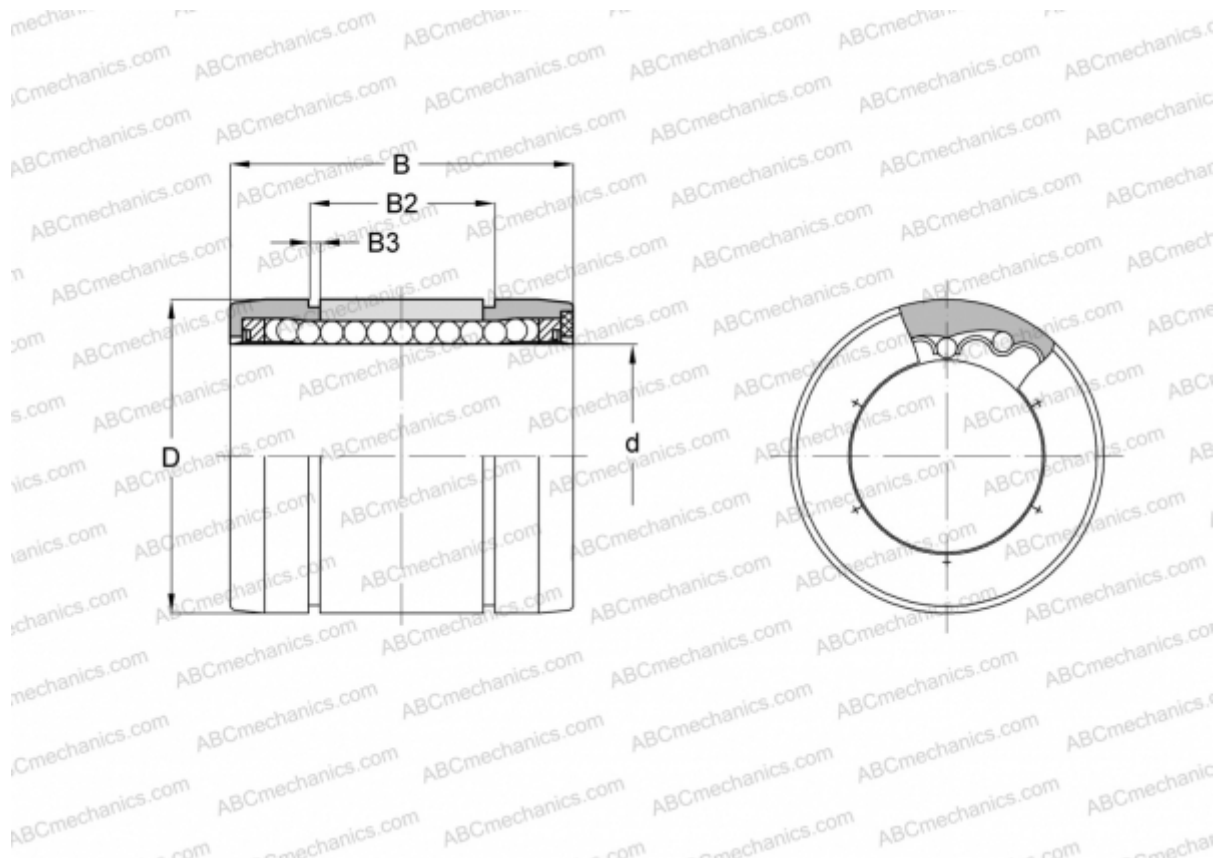

Technical specification

DIMENSIONS, MM

d	12,700
D	22,225
B	31,750
B2	26,213
B3	1,270

WEIGHT, KG 0,023

MANUFACTURER [SAMICK](http://www.samick.com)