

LMBS16 UU SAMICK

Linear bushing

TYPE: Shaft guidance systems, Linear bushing, Self aligning, Close type, Type LMBS, American standard (SAMICK)

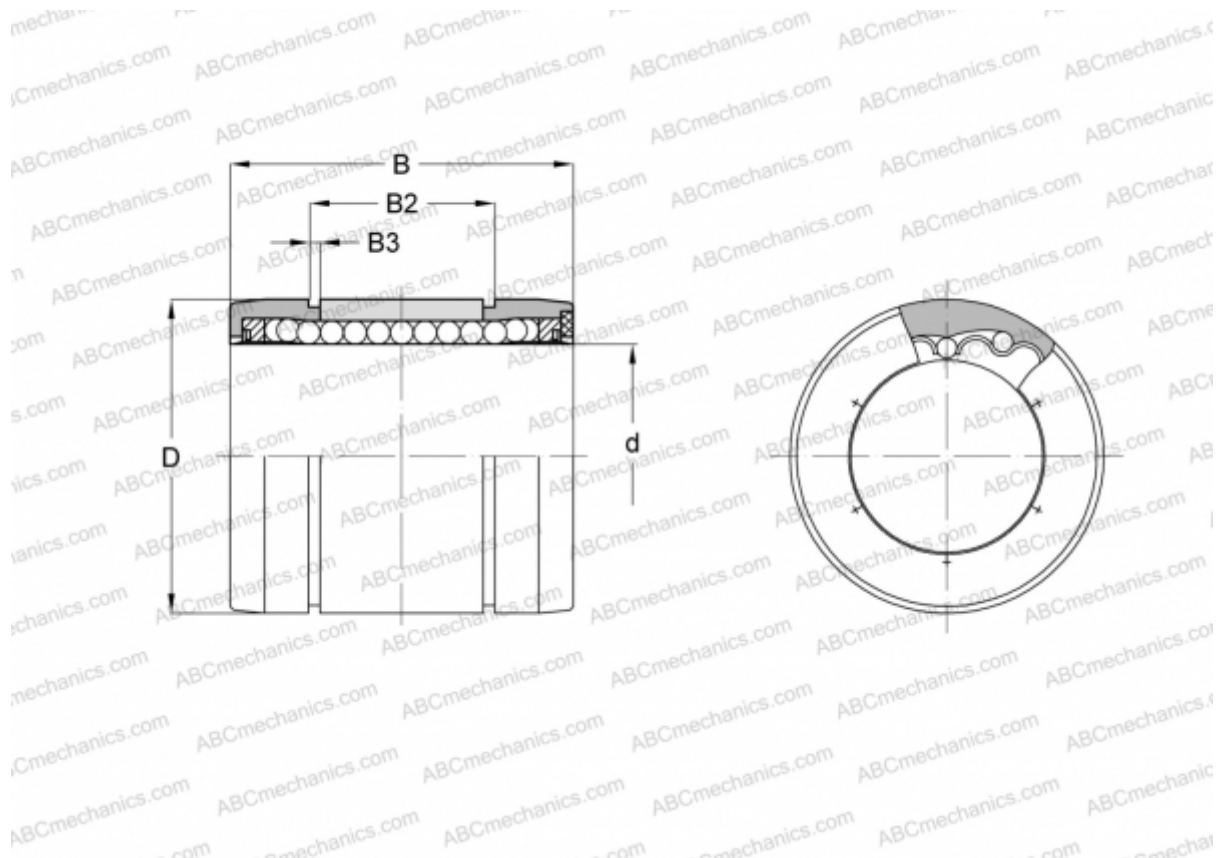

Technical specification

DIMENSIONS, MM

d	25,400
D	39,688
B	57,150
B2	47,854
B3	1,778

WEIGHT, KG 0,132

MANUFACTURER [SAMICK](http://www.samick.com)