

LMES12 UU OP SAMICK

Linear bushing

TYPE: Shaft guidance systems, Linear bushing, Self aligning, Open type for support rail, Type LMES..OP, European standard (SAMICK)

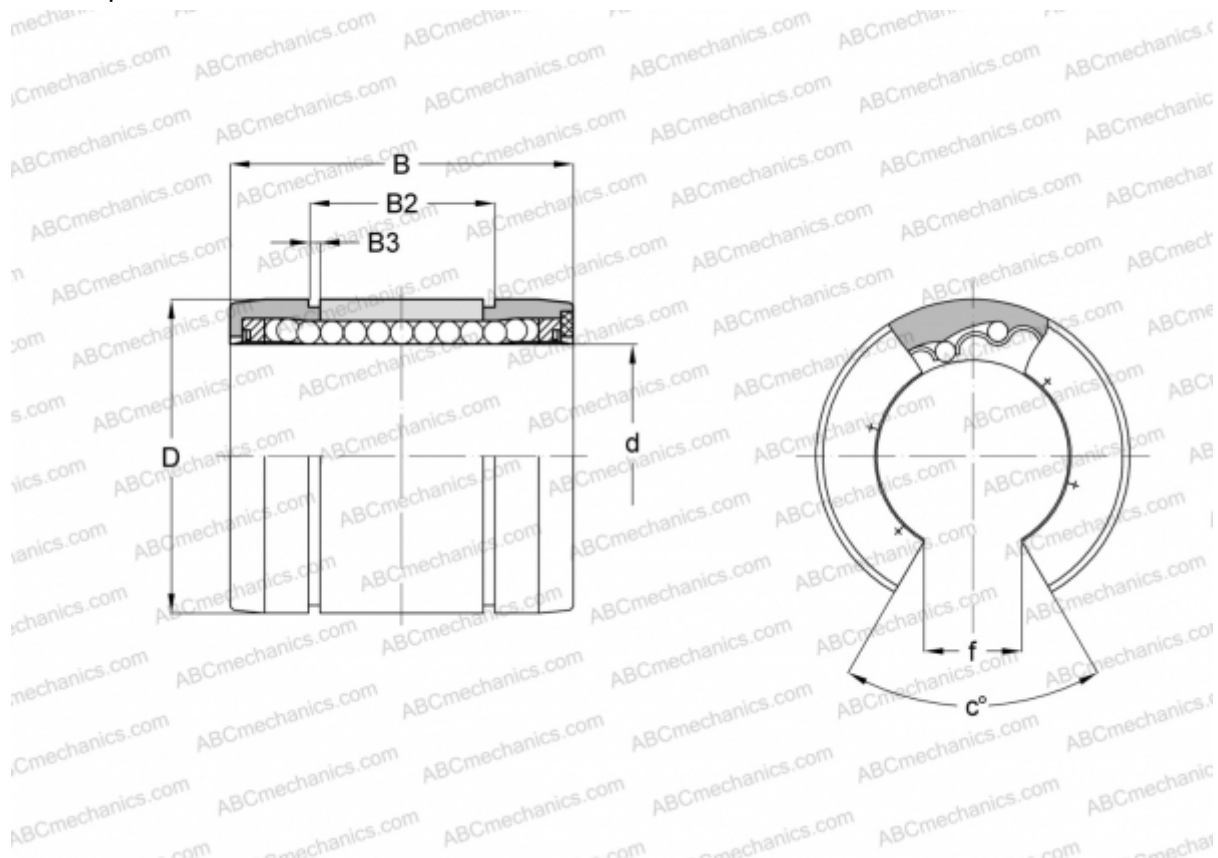

Technical specification

DIMENSIONS, MM

d	12,000
D	22,000
B	32,000
B2	22,700
B3	1,350
f	6,500
c	66

WEIGHT, KG 0,018

MANUFACTURER [SAMICK](http://www.samick.com)