

## LMES16 UU OP SAMICK

Linear bushing

TYPE: Shaft guidance systems, Linear bushing, Self aligning, Open type for support rail, Type LMES..OP, European standard (SAMICK)

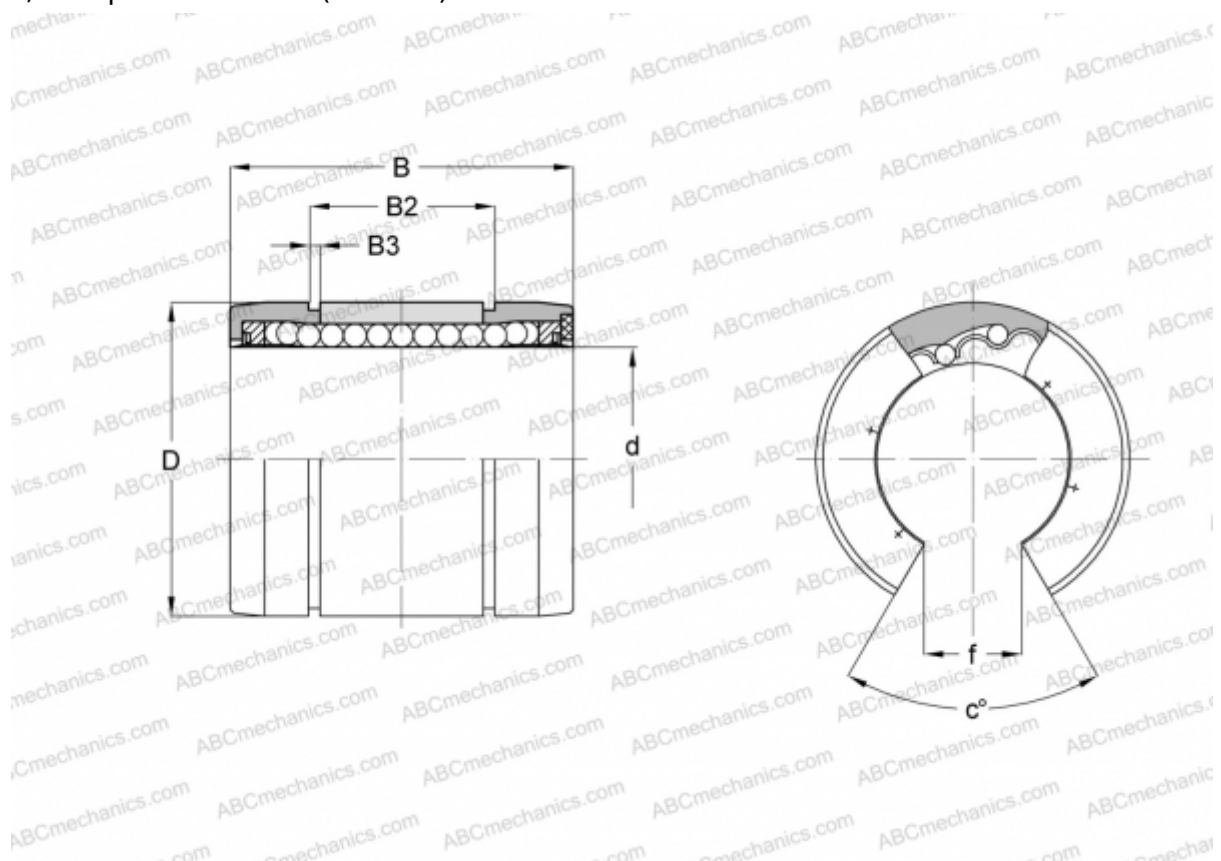

### Technical specification

#### DIMENSIONS, MM

d	16,000
D	26,000
B	36,000
B2	24,700
B3	1,350
f	9,000
c	68

**WEIGHT, KG** 0,022

**MANUFACTURER** [SAMICK](http://www.samick.com)