

LMES20 UU OP SAMICK

Linear bushing

TYPE: Shaft guidance systems, Linear bushing, Self aligning, Open type for support rail, Type LMES..OP, European standard (SAMICK)

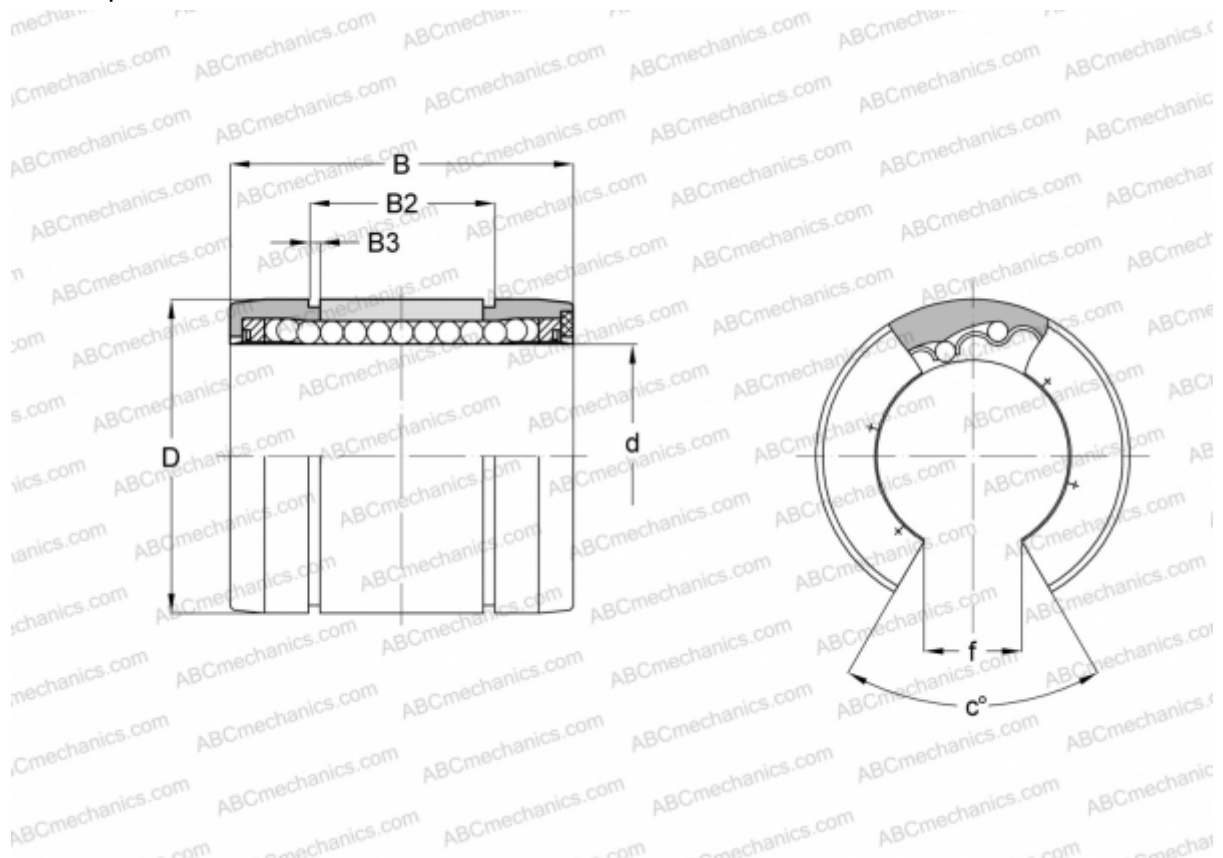

Technical specification

DIMENSIONS, MM

d	20,000
D	32,000
B	45,000
B2	31,300
B3	1,650
f	9,000
c	55

WEIGHT, KG 0,051

MANUFACTURER [SAMICK](http://www.samick.com)