

## LMES25 UU OP SAMICK

Linear bushing

TYPE: Shaft guidance systems, Linear bushing, Self aligning, Open type for support rail, Type LMES..OP, European standard (SAMICK)

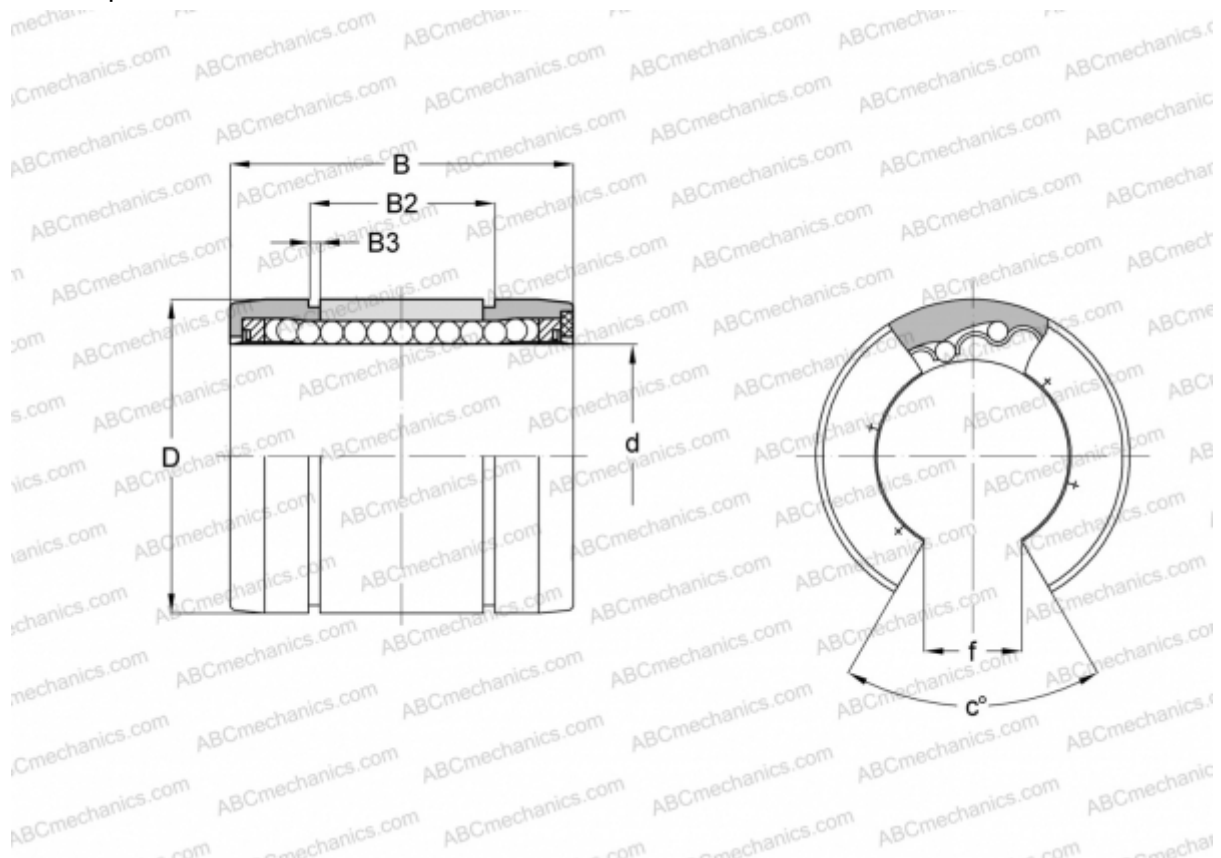

### Technical specification

#### DIMENSIONS, MM

d	25,000
D	40,000
B	58,000
B2	43,800
B3	1,900
f	11,500
c	57

**WEIGHT, KG** 0,102

**MANUFACTURER** [SAMICK](http://www.samick.com)