

LMBS16 UU OP SAMICK

Linear bushing

TYPE: Shaft guidance systems, Linear bushing, Self aligning, Open type for support rail, Type LMBS..OP, American standard (SAMICK)

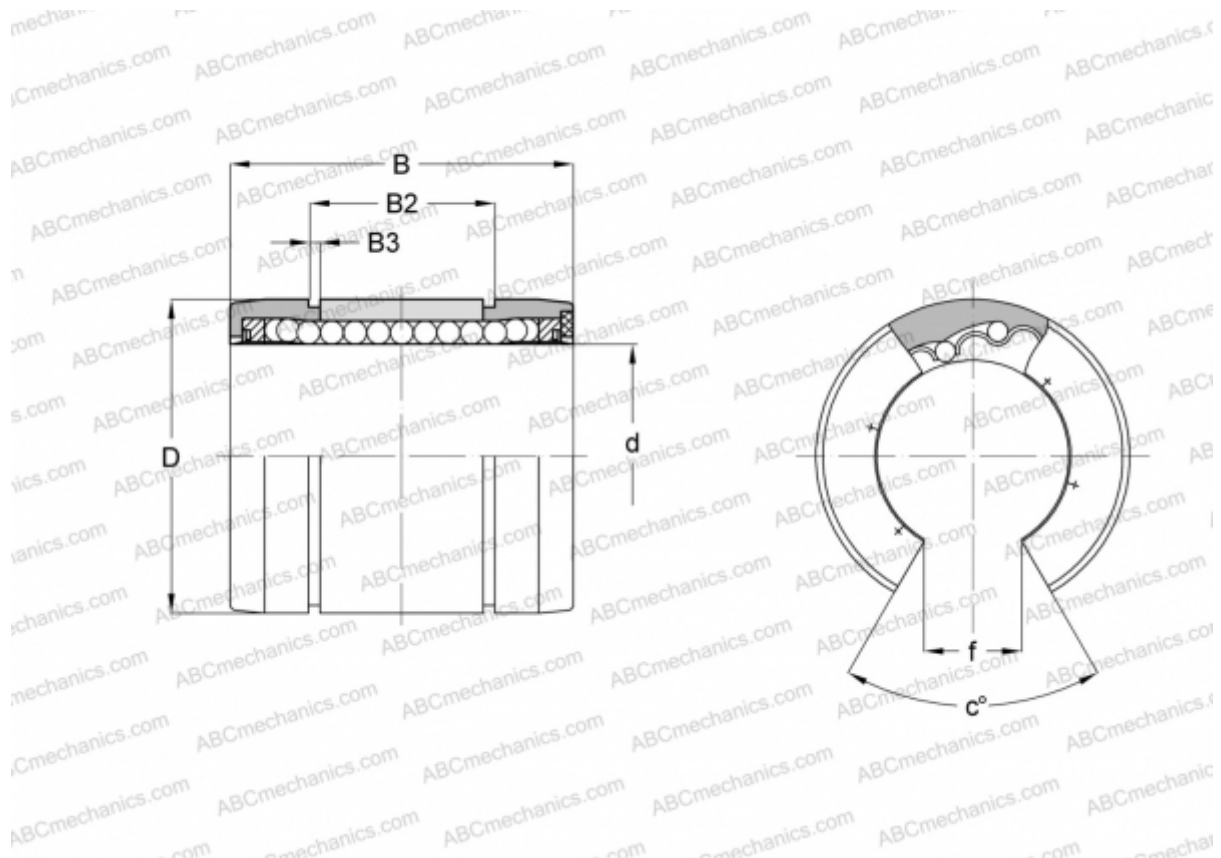

Technical specification

DIMENSIONS, MM

d	25,400
D	39,688
B	57,150
B2	47,854
B3	1,778
f	14,224
c	30

WEIGHT, KG 0,095

MANUFACTURER [SAMICK](http://www.samick.com)