

LMBS24 UU OP SAMICK

Linear bushing

TYPE: Shaft guidance systems, Linear bushing, Self aligning, Open type for support rail, Type LMBS..OP, American standard (SAMICK)

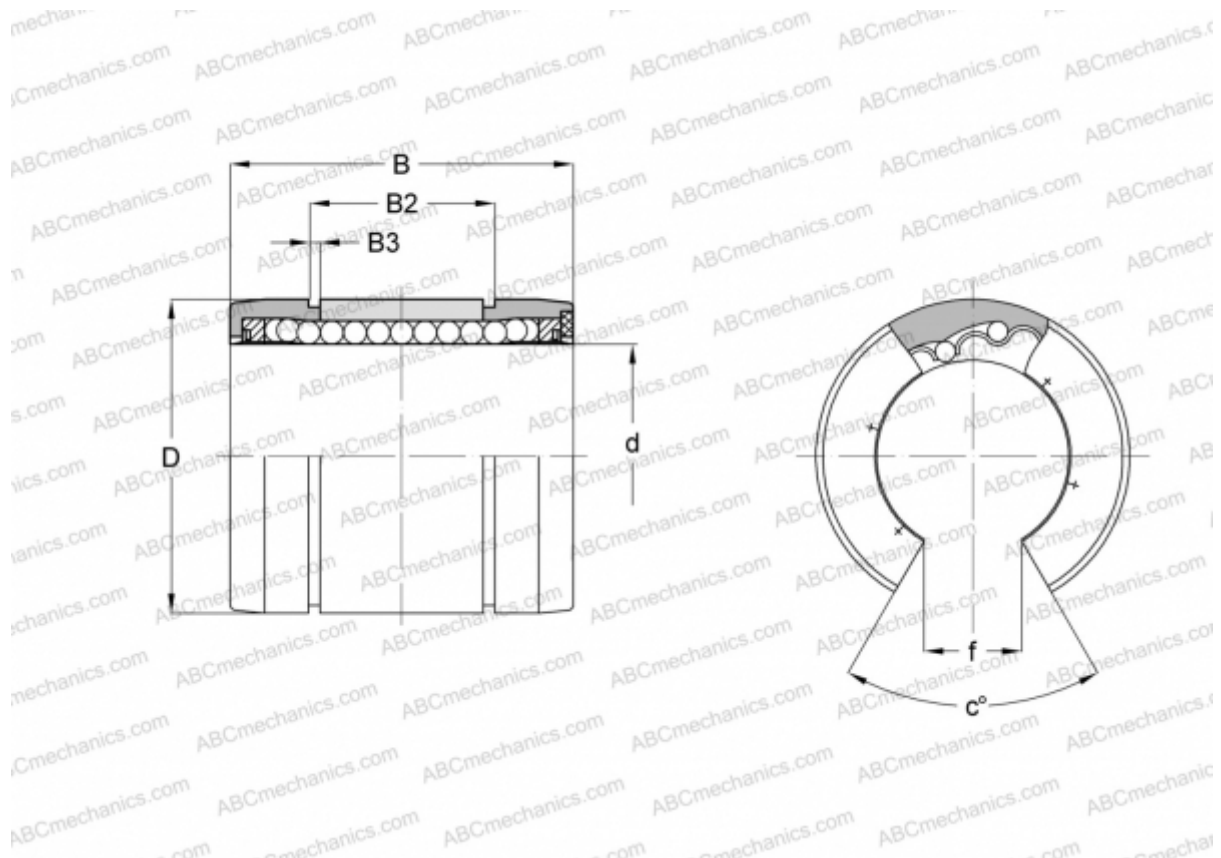

Technical specification

DIMENSIONS, MM

d	38,100
D	60,325
B	76,200
B2	61,214
B3	2,184
f	19,050
c	30

WEIGHT, KG 0,304

MANUFACTURER [SAMICK](http://www.samick.com)